



# From one computer desk to Europe's fastest-growing furniture company

## 10 year warranty

This is our promise of  
longevity and sustainability.

Our story began in 1991. We set out on a mission to make quality and modern workspaces available to more people.

From a single product – a desk for a computer in 1991, our range grew to offer everything you need to furnish a modern office.

We produce diverse products from desks and chairs to acoustic furniture rich in technological solutions.

All of this is done in Lithuania, home to one of the largest office furniture factories in Eastern and Central Europe.

Apart from the constantly expanding production capabilities and technologies, over time our company has developed strong in-house innovation, custom-made furniture, IT, logistics, customer support departments.

All of this allows us to ensure the quality of every single step in product development.



Scan and see Warranty statement



ABOUT US	> 5
DESIGNERS	> 8
DESKS & TABLES	> 14
STORAGE	> 126
ACOUSTIC SOLUTIONS	> 164
CHAIRS	> 216
LOUNGE & SOFT FURNITURE	> 310
EXECUTIVE FURNITURE	> 352
RECEPTION FURNITURE	> 376
CUSTOM-MADE PRODUCTS	> 394
FINISHES	> 406
DEFINITION OF ICONS	> 410

# FROM CONCEPT TO FULL EXECUTION

“  
*I also found out that, just like me, our customers like functional and good quality products and are not willing to pay for what they do not need. That is why we design and manufacture functional, high-quality, attractive yet simple things. Our design motto is: Nothing unnecessary.*

Petras Narbutas,  
company founder and owner

## Concept & Design

---

### In-house design team

Our award-winning in-house design team comprises professionals with almost 30 years of experience in furniture production and design. The achievements of the team were most recently celebrated by the prestigious Red Dot Award for Product Design 2019.

### Working with international designers

6 NARBUTAS experienced product development team and innovation group work closely together to find optimal, high-quality solutions. Additionally, we collaborate with internationally known designers from Lithuania, Italy, Denmark, Japan, etc. Long-term work with international partners brings great results.

*Find more about our work with designers on pages 8-13.*

### Globally relevant

By combining Italian design, subtle Scandinavian minimalism, and natural Lithuanian coziness, we deliver design that will outlast short-lived regional fads and will be easy to integrate, expand, or combine with existing furniture and interior solutions.

### Nothing unnecessary

It matters to us that our furniture is functional, high-quality, and attractively designed, and at the same time, we make sure that our customers do not have to pay for what they do not need.

## Manufacturing

---

The continuous modernization and automation of NARBUTAS furniture factory in Lithuania ensure a reliable production process and the highest quality of furniture produced, both standard and custom-made.

### Using advanced technology

We make substantial investments in machinery and automate processes for our people to be able to focus on what really matters. Our main goal is to reduce the workload for our employees and to increase our production volume.

### Integrating lean production

We follow the lean method to be able to hedge against the risk of error even during the rapid growth of volumes. We are growing at an incredible speed: around 40% a year. The lean method has allowed us to be flexible and to eliminate all possible errors in advance. Even with this growth, we are continuing to manufacture within the 2-week window that has always been our standard.

### Assuring quality

Our quality control is executed in multiple stages to assure there are no errors in the final result. First, we check the quality of materials received from our suppliers, secondly, the components produced, finally, one more inspection of the completed components is conducted before the packaging process. While all these processes take a long time, they enable us to ensure that only high-quality products are delivered to our customers.

## Set-up & Consulting

---

We offer various solutions aimed at making the whole process, from choosing your furniture to setting it up as quick and simple as possible.

### Extensive customer support

Highly qualified NARBUTAS customer support team speaks seven languages (Lithuanian, English, French, German, Russian, Italian, Polish). Dedicated key account managers assure timely response and work with tight client feedback loops.

### Tailored visualizations

Our team will help you make the most of your office space by suggesting a layout for your office and the furniture according to your expressed needs. We make it easier for you to imagine products in your space by creating tailored 3D visualizations.

### Online ordering system and additional services

NARBUTAS online price list contains extensive information regarding our product ranges and services including catalogues, product presentations, technical sheets, operation manuals, and pictures. All of our assembling schemes are made available on our website or can be found by scanning the QR code on the box of the product. This way we make it easier for clients to plan the assembling process and time in advance. We provide videos explaining the more difficult parts of assembling. For your convenience also provide full support in logistical arrangements.

## Custom-made solutions

---

There is no office culture that works in the same way, there is no team that has the same needs. This is why we specialize in custom-made office furniture that attends to individual needs.

### Flexibility & professionalism

Experienced team of professionals can adapt the size or materials of our current standard products to suit your office requirements or create new ones. Engineers of Non-standard Furniture Department will consider every last detail to suggest the best solution and bring your vision to life. All ideas turn into functional and ergonomic office furniture.

### Technical capacity

Our state-of-the-art equipment is highly universal and allowing us to manufacture both large and small individual orders. It makes us very flexible when it comes to customer requests and the capability of realizing even the most complex projects. We have mastered the use of diverse materials, creating furniture with bentwood or metal elements of varying complexity, as well as upholstered and acoustic furniture.

*Find more about the custom-made solutions we offer our customers on pages 394-405.*

# Christina Strand and Niels Hvass



“ We met the NARBUTAS team and felt that the company’s strategy fitted into our way of working. We developed a good relationship and met great enthusiastic people who want to move the company forward.

Strand + Hvass have many years of experience in the world of design. Over the years, their style has developed to become modern and innovative, yet based on classic values and a timeless aesthetic. They have a bold vision of the value and impact of design on today’s world and create unique products to match.



**TWIST&SIT**

> 272 VISITOR, CONFERENCE & DINING CHAIRS  
 > 302 HIGH CHAIRS  
 > 320 LOUNGE & SOFT FURNITURE  
 > 324 LOUNGE & SOFT FURNITURE



**TWIST&SIT Soft**

> 314 LOUNGE & SOFT FURNITURE  
 > 316 LOUNGE & SOFT FURNITURE



**SOFT ROCK**

> 328 LOUNGE & SOFT FURNITURE



**JAZZ**

> 102 CONFERENCE & MEETING TABLES  
 > 118 HIGH TABLES



**JAZZ Silent Box**

> 200 ACOUSTIC FURNITURE



**JAZZ Chill Out**

> 340 LOUNGE & SOFT FURNITURE

# Paolo Pampanoni



“ I want to discover new forms and bring more colors to a modern office.

Paolo Pampanoni is an Umbria-based architect specializing in architecture for work and design. His leading principle is the “performance principle”: every aspect of the design of space or products must lead to a formal, functional, technical, or economic performance.



**ZEDO**

> 40 DESKS  
 > 84 CONFERENCE & MEETING TABLES



**ZEDO PET**

> 188 ACOUSTIC DESK SCREEN



**PLANA**

> 94 CONFERENCE & MEETING TABLES  
 > 366 EXECUTIVE FURNITURE



# Baldanzi & Novelli Designers



“  
The extraordinary thing I have discovered in Lithuania is the desire to create things. While working together hand in hand our two cultures mix and complement each other resulting in a third element – an energy that cannot be found elsewhere.

Collaboration of Baldanzi & Novelli designers and NARBUTAS began in 2013 with mutual interest. NARBUTAS were interested in Baldanzi & Novelli's more than 30 years of experience, great design culture, originality, and familiarity with cutting-edge technology, while the designers were attracted to the company's clear-cut vision and recognizable style.

# Roberto Lucci

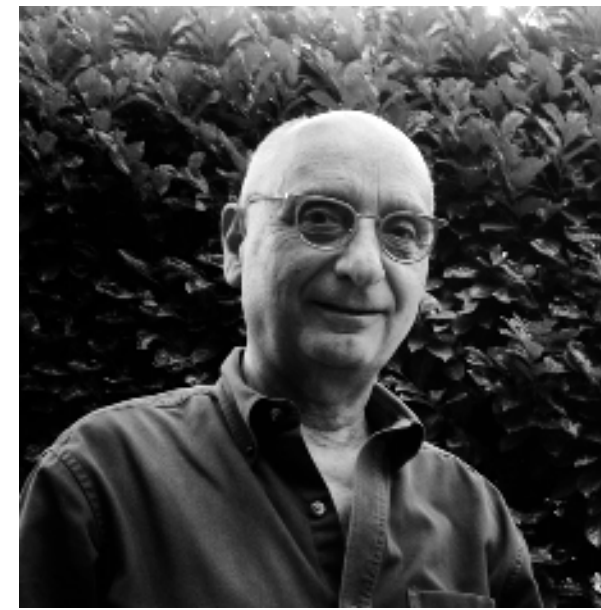

“  
Creativity alone is not design and problem solving without creativity is not design either.

Roberto Lucci has been designing for over half a century, always driven by the notion that design is creative problem-solving.



## WIND

- > 226 TASK CHAIRS
- > 254 HIGH SWIVEL CHAIRS
- > 268 VISITOR, CONFERENCE & DINING CHAIRS

- > 234 TASK CHAIRS
- > 236 VISITOR, CONFERENCE & DINING CHAIRS
- > 258 EXECUTIVE CHAIRS



## WORKLAB

## ARCIPELAGO

## ARCIPELAGO Wood

- > 108 DESKS
- > 108 LOUNGE & SOFT FURNITURE
- > 108 LOUNGE & SOFT FURNITURE

- > 334 LOUNGE & SOFT FURNITURE
- > 210 ACOUSTIC FURNITURE



## PLANA

- > 98 CONFERENCE & MEETING TABLES
- > 366 EXECUTIVE FURNITURE

# Kazuko Okamoto



“ I find it interesting to create furniture that proposes ways to use it, to live, and to make a place without being restricted by a pre-existing concept.

Born in Chiba, Japan, Kazuko Okamoto spent ten years after her graduation from Tokyo's ICS College of Arts working in Japan before moving to Milan and working for a studio, then as a freelance designer. Her unique point of view earned her second place at the "Only for Women 2001 Awards" at Milan's Salone del Mobile. functional, technical or economic performance.



## CUMULUS

> 345  
LOUNGE  
& SOFT  
FURNITURE

# Gediminas Juška



“ I associate Narbutas with professionalism, solidity, and consistency. The company's products stand for high quality and a modern, elegant design.

Gediminas Juška began working with NARBUTAS in 2000, soon after completing his architecture degree at the Vilnius Academy of Arts. Since then his creations for the company have won the Grand Prix at the Furniture 2001 Fair, the Main Prize of Good Design 2012, and other prizes at national and international events. Juška has always specialized in office furniture and interiors, and his achievements have earned him recognition in Lithuania and beyond.



## MOVE&LEAD

> 354  
EXECUTIVE  
FURNITURE



## AIR

> 76  
DESKS

> 100  
CONFERENCE  
& MEETING  
TABLES

> 370  
EXECUTIVE  
FURNITURE

# DESKS & TABLES

## SIT-STAND DESKS



**B-ACTIVE**  
> 20



**ONE**  
> 38



**ACTIVE**  
> 24



**MOTION**  
> 28



**EASY**  
> 34

14

## DESKS



**ZEDO**  
> 40



**T-EASY**  
> 80



**ROUND**  
> 52



**ONE H**  
> 81



**NOVA Wood**  
> 62



**OPTIMA C**  
> 82



**NOVA**  
> 68



**OPTIMA Plus**  
> 83



**AIR**  
> 76



**WORKLAB**  
> 108

15



# CONFERENCE & MEETING TABLES



**ZEDO**  
> 84



**AIR**  
> 100



**FOLDING**  
> 106



**NOVA Wood**  
> 88



**JAZZ**  
> 102



**FORUM**  
> 107



**NOVA Wood Multipurpose**  
> 92



**FLIP-TOP**  
> 104



**OPTIMA**  
> 107



**PLANA**  
> 94



**FLIP-TOP.II**  
> 104



**T-EASY**  
> 107



**NOVA**  
> 98

# CONFERENCE WALLS



**WORKLAB**  
> 108



**MEDIA**  
> 112



**COMBUS**  
> 128

# HIGH TABLES



**NOVA Wood Multipurpose**  
> 114



**JAZZ**  
> 118



**NOVA Wood**  
> 116



**NOVA**  
> 118



**LIGHT**  
> 118

# OCCASIONAL TABLES



**NOVA Wood**  
> 120



**NOVA**  
> 124



**MOBI**  
> 122



**NOVUS**  
> 124



**AMBER**  
> 123



**FORUM**  
> 125



**SITO**  
> 123



**OPTIMA**  
> 125

# B-ACTIVE

Enjoy more freedom,  
physical activity and  
productivity!

B-ACTIVE is a practical electric height-adjustable  
desk that stands for ergonomics and quality,  
which is now even more accessible to customers.



↑  
MAX  
1175 mm  
MIN  
705 mm  
↓

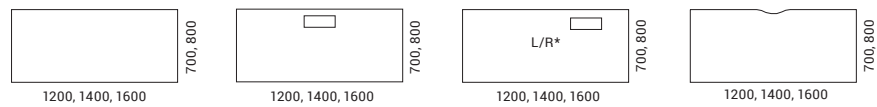

\* - left/right



## Every detail matters

You can choose from two different types of metal legs.  
Create your own custom B-ACTIVE desk by choosing  
desired components from the desktop right down to  
the feet.



## Safety and stability

For greater safety at the workplace, B-ACTIVE has  
an integrated anti-collision feature and a feature  
protecting the desk against overloading.



BERTA  
AD7

22

SYNERGY  
S62

23





# ACTIVE

An easy way to stay active at work!

ACTIVE desking system can be best described in two words: functionality and quality.



24

25

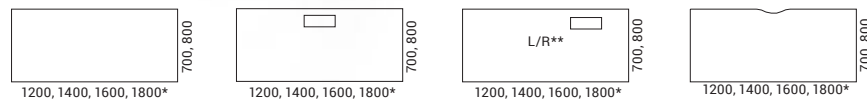

\* - only 800  
\*\* - left/right



## Easy to customize

The desk height can be adjusted by pressing a selected button: a memory position button with a display, or up and down controls.



## Feet design

Choose from three types of metal feet. All the designs look minimalist, light and with different elegant accents.

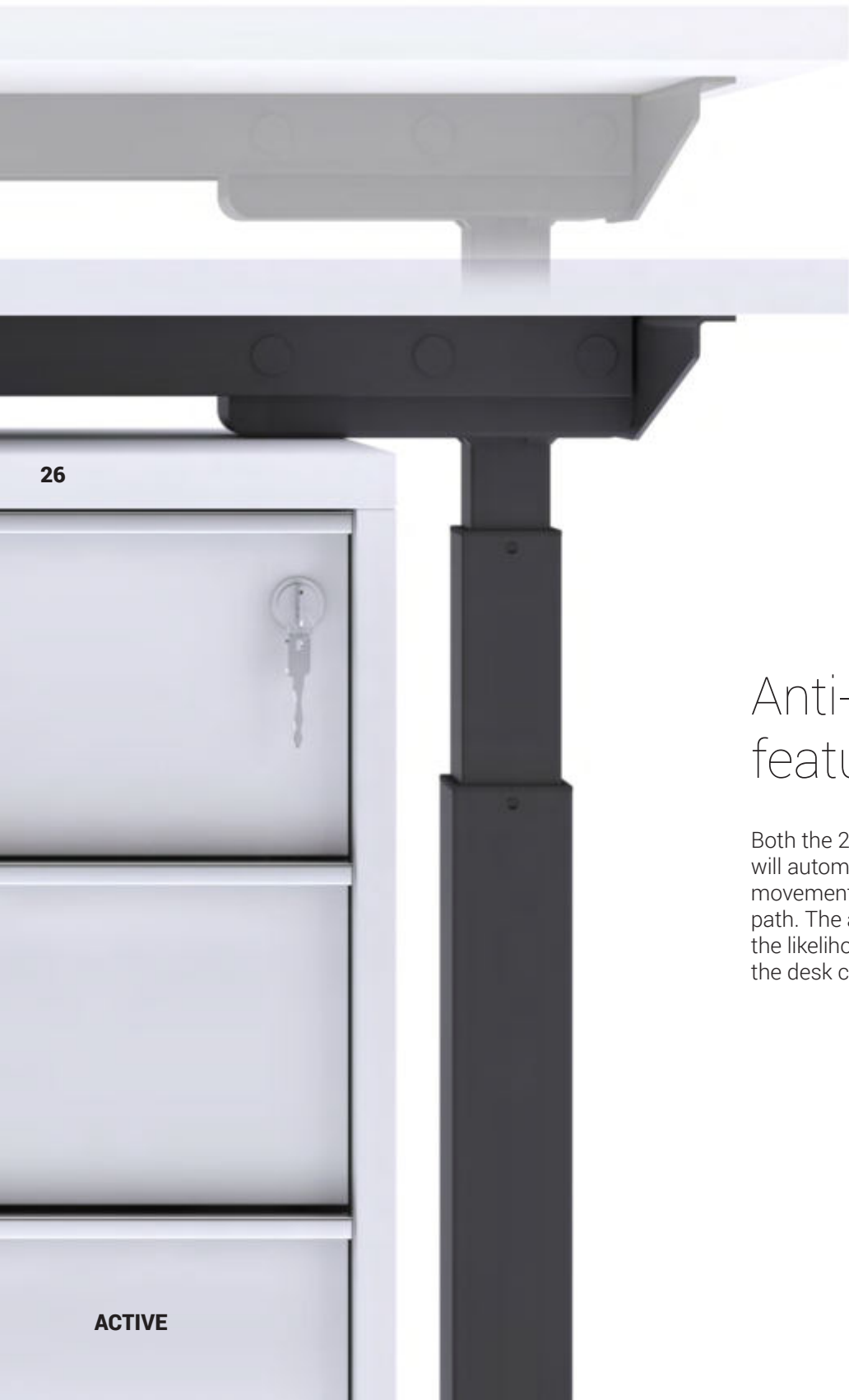

26

ACTIVE

## Anti-collision feature

Both the 2-level and 3-level feet sensor will automatically stop the desk's movement if it senses an obstacle in its path. The anti-collision feature reduces the likelihood of damage should the desk collide with a hard object.



27

ACTIVE



SIT-STAND  
DESKS

# MOTION

> 360  
EXECUTIVE  
FURNITURE

Makes you move  
forward!

The system is available as single desks or bench desks designed for a flexible arrangement of workstations as well as for individual or group work.

28



↑  
MAX  
1200 / 1300 mm  
  
MIN  
650 / 700 mm  
↓

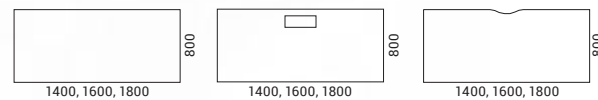

MOTION

SIT-STAND  
DESKS







## Acoustics and concentration

A fixed-height acoustic desk screen MODUS designed for bench desks will ensure acoustic comfort and help your employees maintain concentration. Furthermore, the double-sided acoustic desk screens allow you to create colourful combinations.



## Leg design

MOTION desks offer a choice of two different leg designs. H-shaped metal legs provide a more generous space for movement and storage. Those who desire more privacy can choose a desk with panel legs which visually cover up the space under the desk and add an aesthetic look to it.

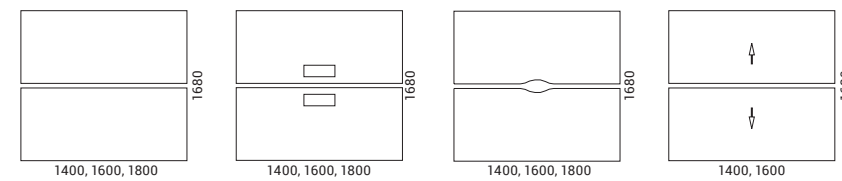







Makes it easy to  
be productive!

Easy to choose, easy to use, and easy to  
stay productive for a longer period of time.

34



↑  
MAX  
1200 / 1260 mm

MIN  
700 / 610 mm  
↓

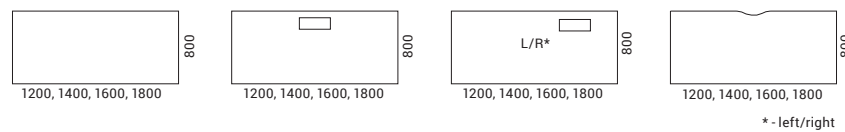

## Stability

Two-desk benches are an excellent solution  
for combining workstations. The shared leg  
of the sit-stand desks provide maximum  
stability of the joined desks.



35

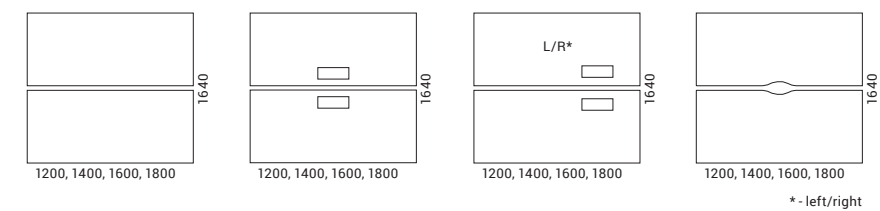



36

XTREME Plus  
Y40

37

EASY

EASY





# ONE

Ideal for any office

ONE sit-stand desks are ideal for any office space thanks to their design and great value for money that they offer.



38

↑  
MAX  
1185 mm  
MIN  
705 mm  
↓

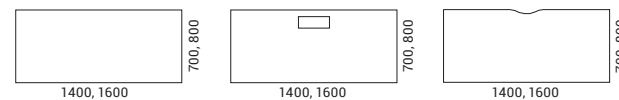

ONE



39

ONE

# ZEDO

Design by Paolo Pampanoni

> 84

CONFERENCE  
& MEETING  
TABLES

Workplace  
that inspires

A work environment with an original character makes employees more engaged and helps them to build and maintain a closer relationship with a company. ZEDO is an inspiring and flexible desk system featuring distinctive design with carefully selected and colourful accessories that will help you create workplaces with a unique character.



40



41

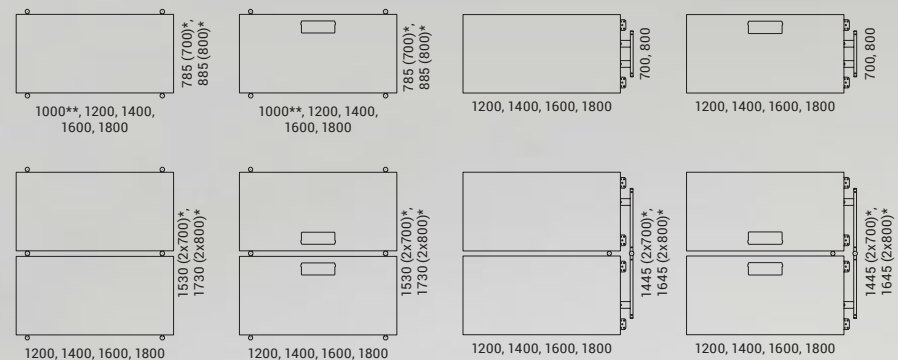

\* - desktop depth  
\*\* - only 785 (700)



# Original design and unique combinations

The main element of the ZEDO design is a round metal leg on the outer part of the table, with a playful coloured plug as the final touch. The original design of the desks offers a very wide range of options for combining the colours of legs, plugs and accessories to create a unique workplace atmosphere.



# Colourful shelves – stylish and practical

Bicoloured metal shelves create a distinctive and stylish look. Shelves of varying forms can be combined with each other and into higher compositions. That way you will also clear your desk of small items and be able to clean it easily as well as disinfect.

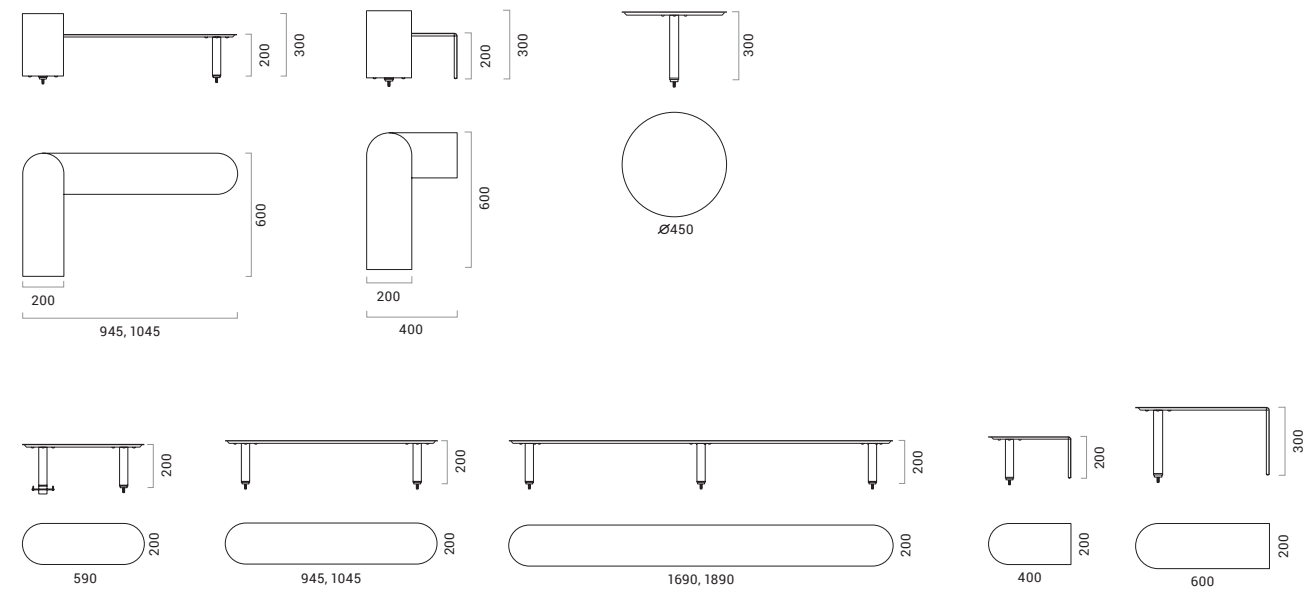



DESKS



For storing items in a minimalist workplace

Thanks to digital technology, a modern workplace is becoming less cluttered and no longer requires many cabinets. Minimalist drawers and open niches with a PET felt lining are perfect for such a case.

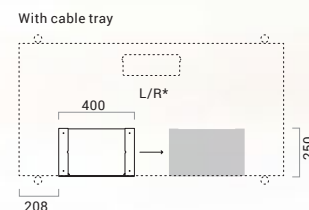
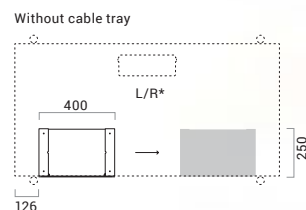
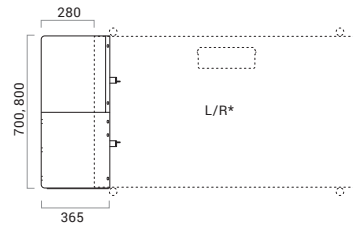

\* - left/right

DESKS

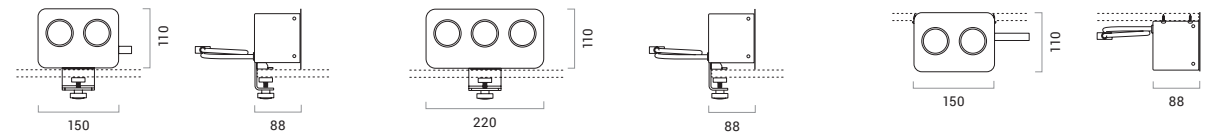

Design continuation in convenient power solutions

Exceptional power units blend in the whole design concept perfectly due to the choice of metal colour and rounded forms. The power unit can be mounted on or under the desk for convenient and quick access to electricity.



## DESKS

An easily adaptable  
return table

Extend your desk possibilities with a rotatable return table  
that can be used for both temporary work while standing  
and short meetings due to its larger height.



46

47

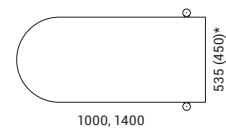

\* - desktop depth

ZEDO

ZEDO





Thought out to the smallest detail

A wide range of pedestals and storage towers allow you to store your personal items conveniently as well as hide cables. The holes in the frames allow you to easily combine several workplaces into a single power circuit, while the elegant metal box with opening grommet provides easy access to the sockets.

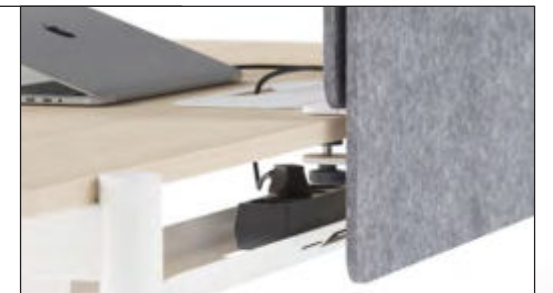

Cable-hiding desk screen construction



Pedestals for convenient item storage



Cut-out for wire management



Metal box for power unit and cable management



A niche for storing items

48

49

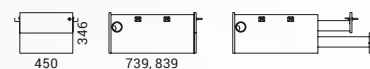
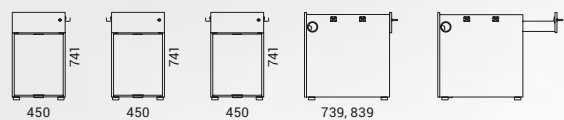
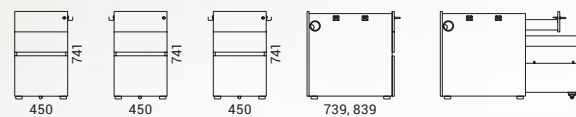
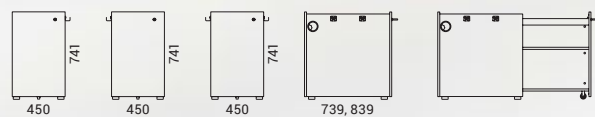





# ROUND

For effective workplace design

Use the office space effectively with a ROUND system which combines office desks, cabinets and screens. Creating open and private workplaces for your team was never as easy.



52

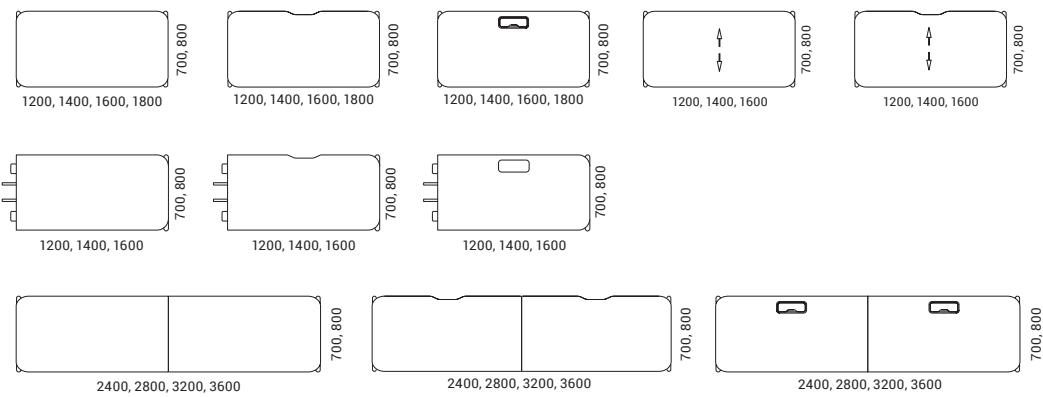

\* Desktops are also available with square corners.



RUNNER mesh RM4

STEP L15



From single desk to bench desks for collaborative tasks



54

55

Create workplaces based on the number of employees and the nature of the tasks performed ranging from single desks to bench desks. The latter are very popular as they enable both small and large teams to create a workspace ideally suited for collaborative tasks.

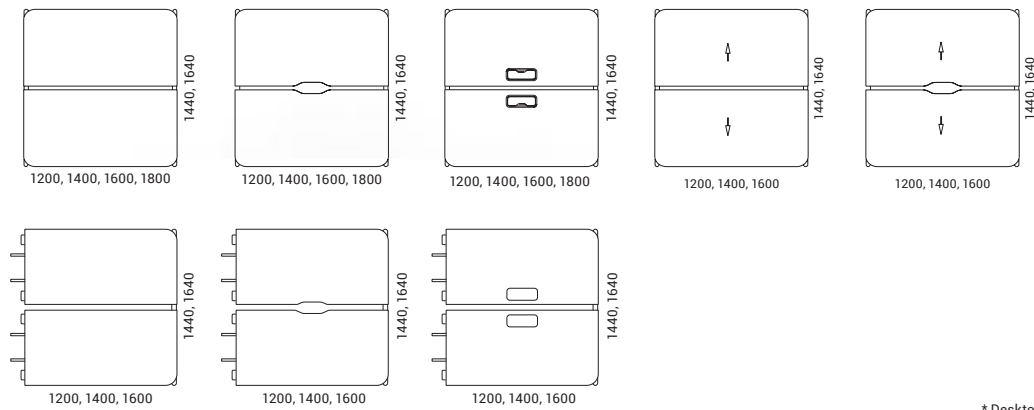

\* Desktops are also available with square corners.

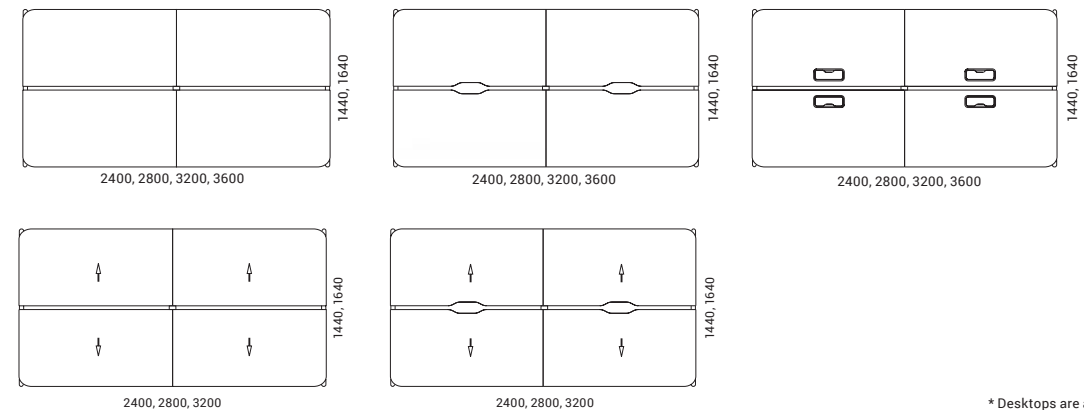

\* Desktops are also available with square corners.

# Modular cabinet system

Desk height cabinets can be made higher with additional shelving units and which can be single-sided or double-sided and open or closed.

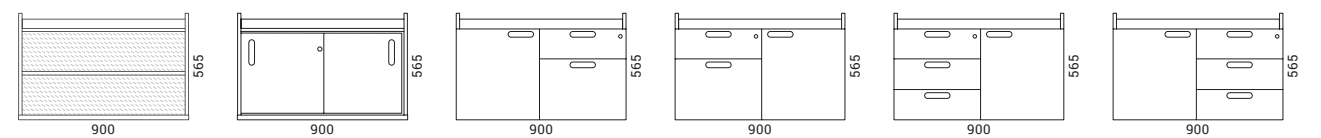
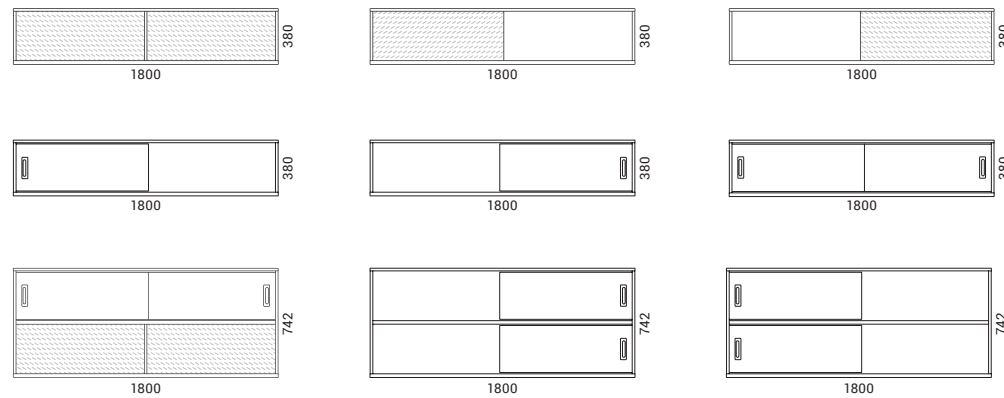



## DESKS

Power management solutions with wide range of applications



58

The ROUND desk system allows for easy connection of several workplaces into a single electrical circuit. Cabinets serve an important function in power supply and data transmission as they come with a grommet for wire and cable management.

ROUND



ROUND



DESKS

DESKS



ROUND

ROUND



DESKS

# NOVA Wood

> 88

> 92

CONFERENCE  
& MEETING  
TABLES

> 114

> 116

HIGH  
TABLES

> 120

OCCASIONAL  
TABLES

A touch of nature  
in your office!

NOVA Wood is a desking system that adds  
a delicate sense of luxury to your office  
and brings you closer to nature and  
home atmosphere!



62

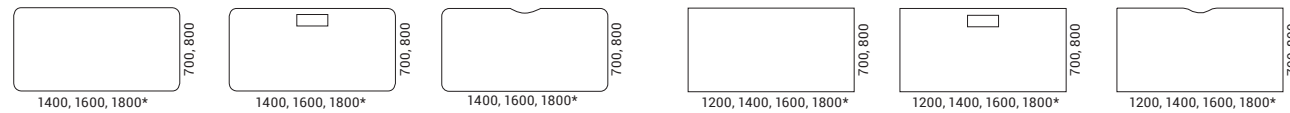

\* - only 800

NOVA Wood

DESKS



NOVA Wood

# Every table is unique

Wood texture and wide growth rings create a distinctive pattern. Stained and lacquered wood reveals the pattern even more. Natural wood tends to change its colour over time.



64

You can adapt bench desks consisting of two desks to your office dynamics by using supplementary partitions which allow you to easily increase the number of workplaces.



65

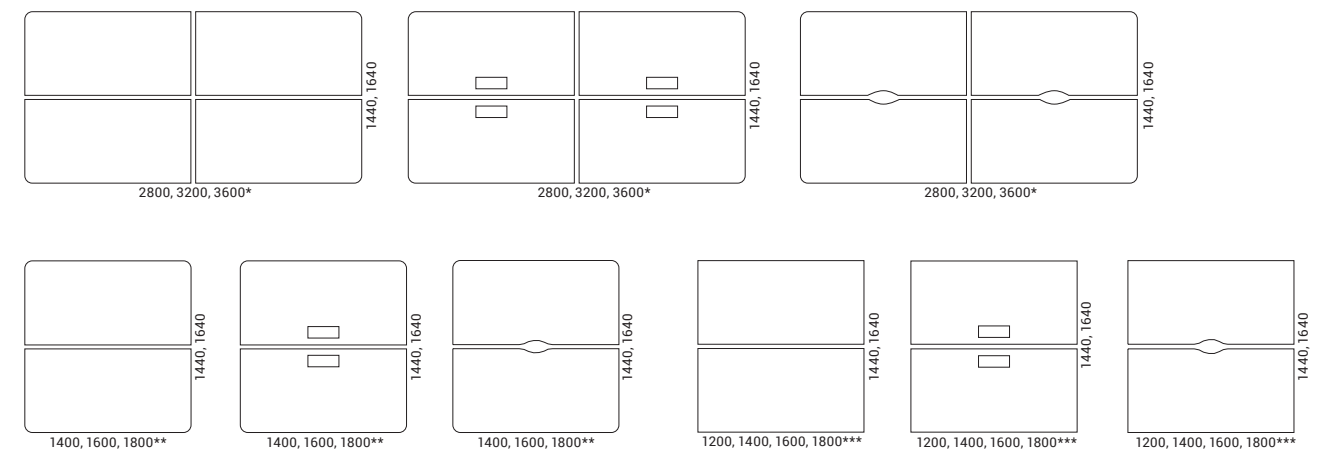

\* - only 1640  
 \*\* - only 800, 1640  
 \*\*\* - only 800



DESKS

DESKS



ERA  
C09



# NOVA

## Modern classic

Even the name itself derived from the Latin word meaning something "new". If you change the desktop texture or leg colour, you will be able to create a whole new desk.



- > 98  
CONFERENCE  
& MEETING  
TABLES
- > 118  
HIGH  
TABLES
- > 124  
OCCASIONAL  
TABLES
- > 374  
EXECUTIVE  
FURNITURE

## U

Regular U-shaped legs is a universal design solution.



## A

A-shaped legs are sure to add subtle look and elegance to NOVA A desks.



## O

O-shape desk legs are unique in that you can additionally order a special divider designed for two-seat and four-seat desks.



## H

Height adjustable feet allow you to easily change the desk height from 620 mm to 850 mm.





# DESKS

You can adapt bench desks consisting of two desks to your office dynamics by using supplementary partitions which allow you to easily increase the number of workplace.

# DESKS

70



71

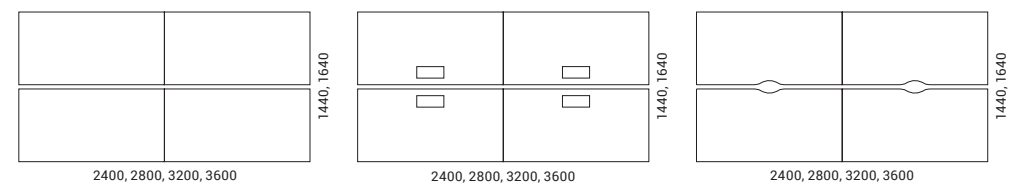
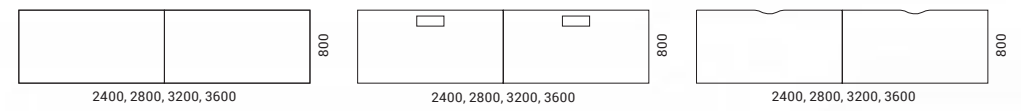
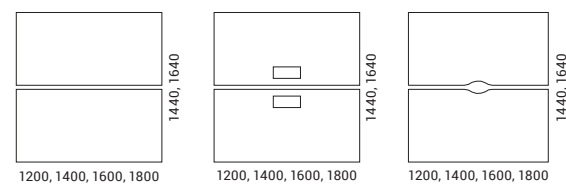
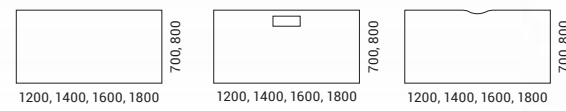

# Sliding desktop

Choose functional NOVA U Slide desks with a push/pull desktop. The arrangement of the cable duct, the access to the power unit and cable management will be much more convenient. These desks are based on a very simple principle: to access the cable duct, pull the desktop toward yourself; if you want to conceal the cables, then simply push the desktop slightly.

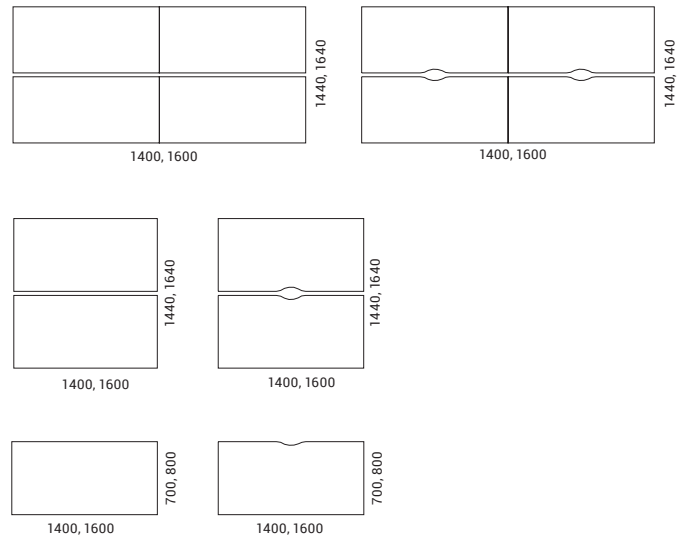

# Clover-shaped teamwork desk

Bench desk with cut-outs for wire management has a clover-like shape. Ideal for setting up a work-space for a team of three people.

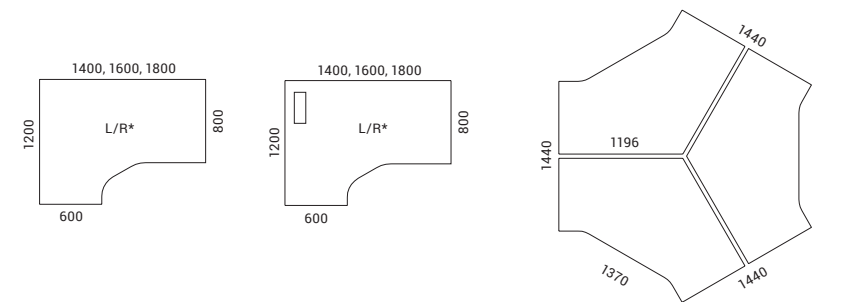



DESKS

DESKS



NOVA

NOVA

# AIR

Design by Gediminas Juška

Furniture that appears as if floating in thin air

An exceptional feature of AIR desks is thin metal legs that convey a sense of lightness and at the same time ensure their durability and stability.



76

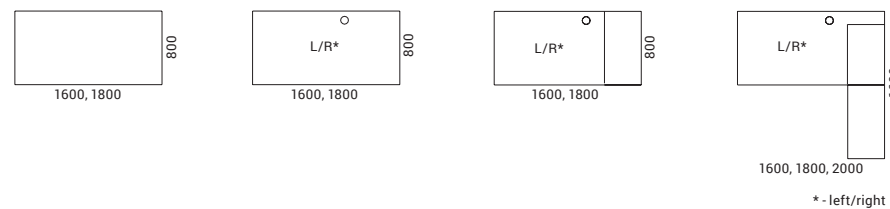

> 100  
 CONFERENCE  
 & MEETING  
 TABLES

370  
 EXECUTIVE  
 FURNITURE

To make even more efficient use of space, choose a cabinet suspended at hand's reach above the desk for storing personal items and office supplies.



77

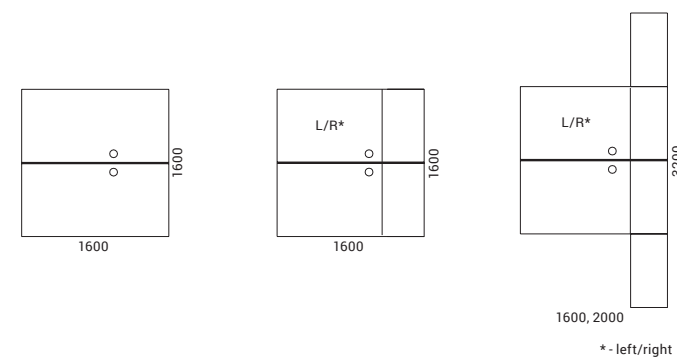
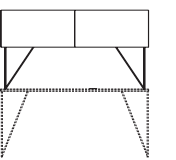

Minimalist AIR designs, thought through solutions, combinations of different textures and colours – all this provides more creative freedom for architects who design office spaces.



DESKS

DESKS

“

*I think that a modern workspace should be functional and light just like pristine nature, crystal-clear water and fresh AIR.*

Gediminas Juška



AIR

AIR

# T-EASY

> 107  
CONFERENCE  
& MEETING  
TABLES

Desks that do not restrict the user's freedom of movement

T-EASY desks are ideal for the office workspace design combines fixed-height desks (H=740 mm) for shorter working periods, and ergonomic electric adjustable desks for regular work which allow the users to change their posture using the sit-stand principle.

80

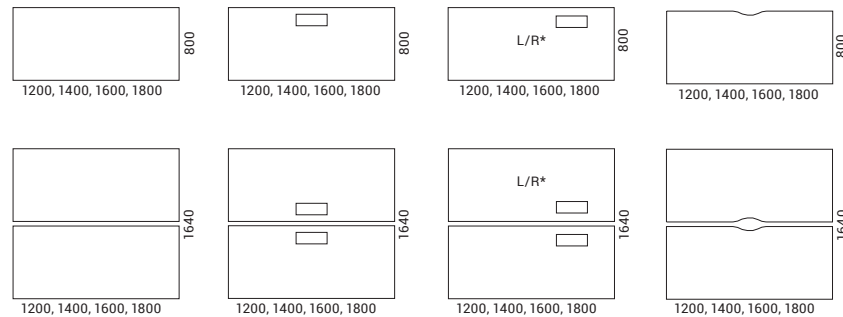

\* - left/right

# ONE H

Ideal for any office

While working at the desk with T-shaped legs, you will be able to enjoy a freedom of movement as there will be more space underneath the table and around it.

81

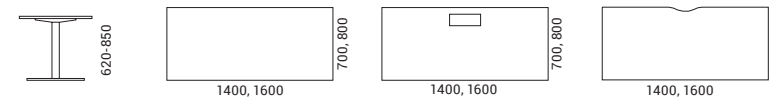



# OPTIMA C

An optimal solution for your workplace

> 83  
DESKS

> 107  
CONFERENCE  
& MEETING  
TABLES

> 125  
OCCASIONAL  
TABLES



It allows you to create a comfortable, functional and well-organized work environment using minimum components. The desk has C-shape double cantilever legs and an insert for discreet management of wires and cables. Choose the type of desktop that meets your needs best.

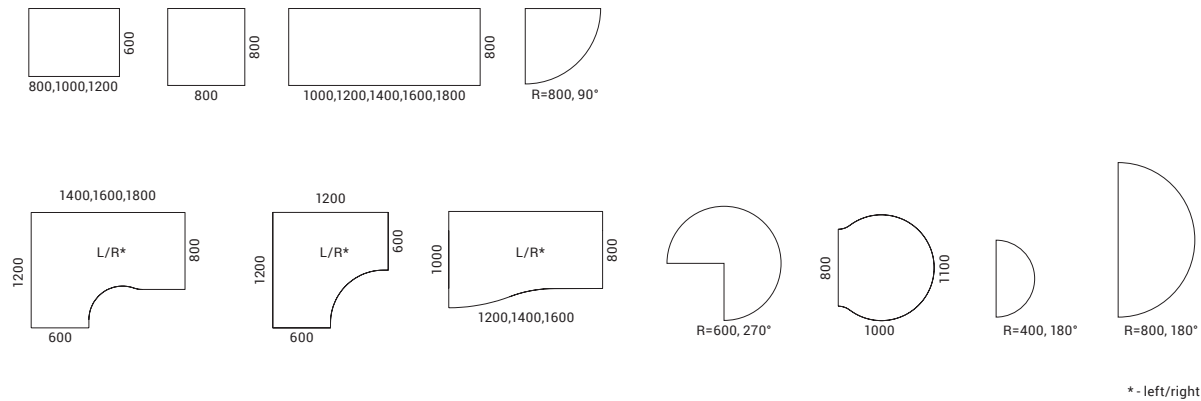

OPTIMA C

# OPTIMA Plus

> 82  
DESKS

> 107  
CONFERENCE  
& MEETING  
TABLES

> 125  
OCCASIONAL  
TABLES



The system includes panel end legs with levelling feet which provides stability on uneven flooring. Choose the type of desktop that meets your needs best: a rectangular desktop, a desktop with left- or right-handed configurations, a corner desktop or a wave desktop.

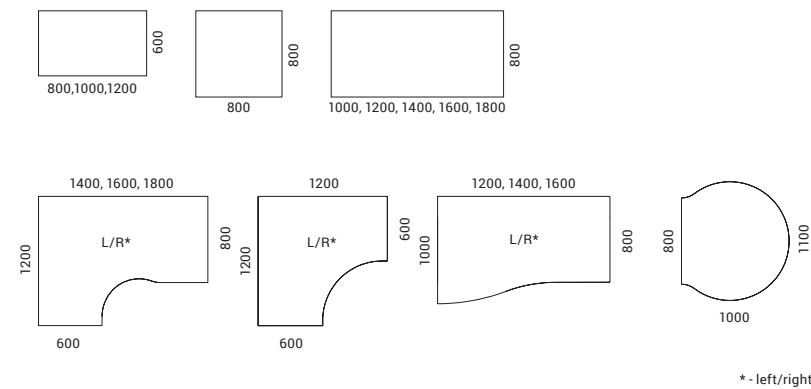

OPTIMA Plus

Design by Paolo Pampanoni

For an inspiring  
workplace for  
meetings

Due to the original design, the ZEDO meeting table can be in a regular shape or, using a supplementary unit and shelves, transform into a unique combination.



Two forms

ZEDO meeting tables are available with square or rounded edges. Depending on the chosen desk size, four to six people can comfortably collaborate at a desk.

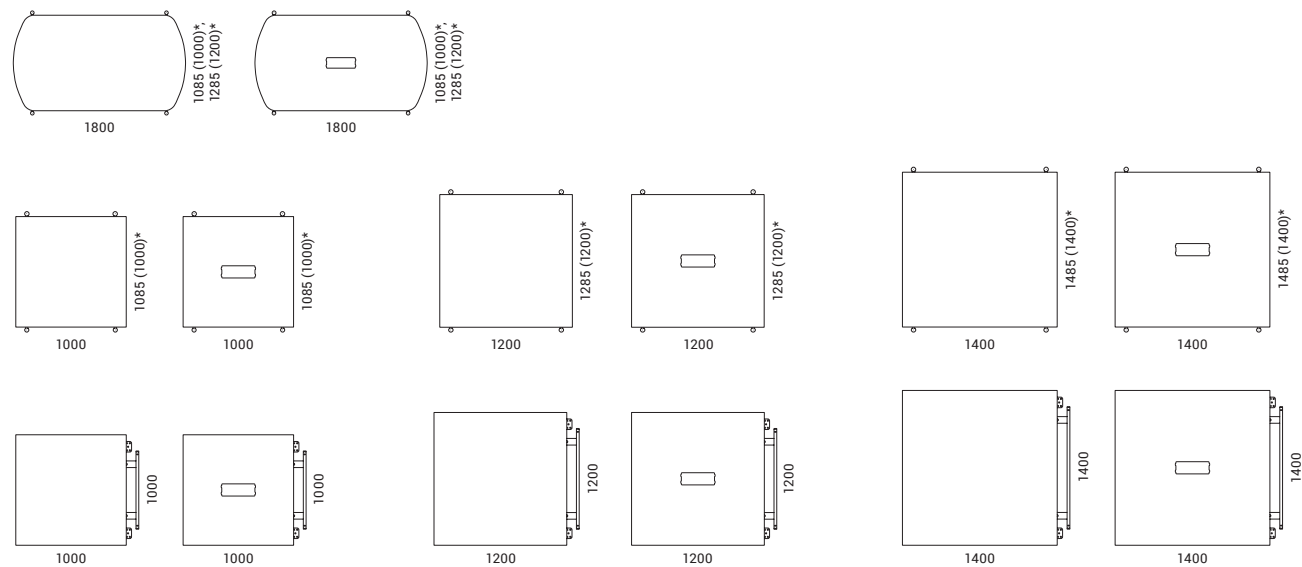

\* - tabletop depth







## Flexible adjustability

Flexibility is an integral feature of a modern workplace. You will easily adjust ZEDO meeting tables to your changing needs and the size of your team. With supplementary units, you can extend a meeting table and set up to 20 workplaces.



# NOVA Wood

NOVA Wood tables offer a subtle sense of luxury and create warm atmosphere thanks to their natural elements. The key distinct feature of these tables are elegant and uniquely patterned solid ash wood legs.



reddot award 2019  
winner

> 62

DESKS

> 92

CONFERENCE  
& MEETING  
TABLES

> 114

> 116

HIGH  
TABLES

> 120

OCCASIONAL  
TABLES

The meeting table has an ash tree veneer insert which is a well-thought out cable management solution for a meeting space.

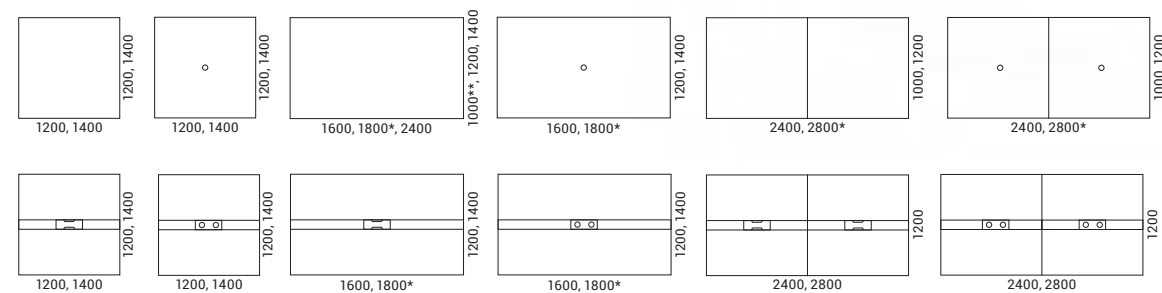

\* - only 1200  
\*\* - only 2400

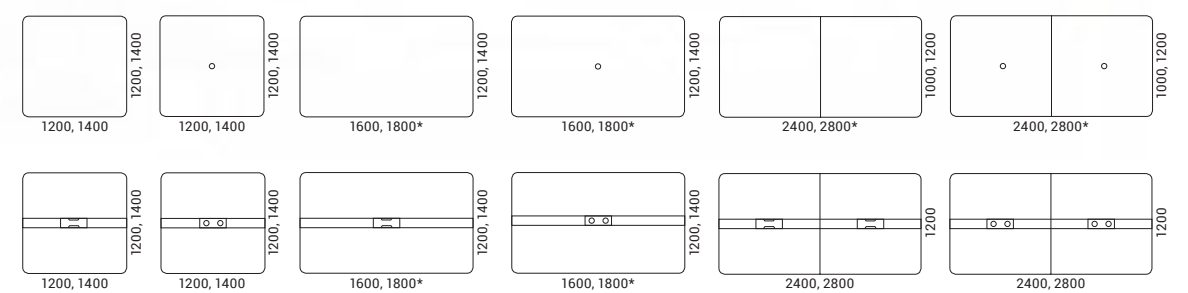

\* - only 1200





STEP  
L15



CONFERENCE  
& MEETING  
TABLES

# NOVA

## Wood

### Multipurpose



92

A cosy multipurpose island for efficient meetings

The multipurpose meeting table can serve as a cosy island for convenient team meetings in an open-plan office. Thanks to the three different height options of the tabletop and the well-designed accessories, the multipurpose NOVA Wood table will enable you to create a more private, practical space for both long meetings or spontaneous stand-up meetings for coming up with quick solutions or generating ideas.

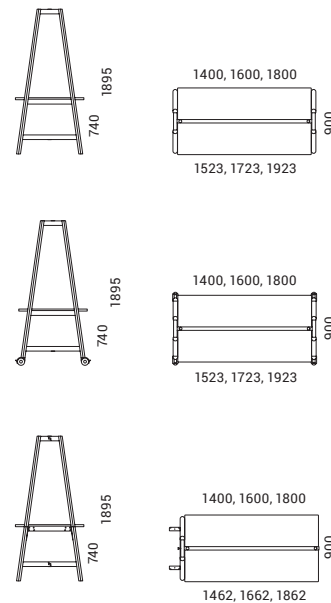

\* Tabletops are also available with cut out for power socket.

NOVA Wood Multipurpose

> 62

DESKS

> 88

CONFERENCE  
& MEETING  
TABLES

> 114

> 116

HIGH  
TABLES

> 120

OCCASIONAL  
TABLES





Design by Roberto Lucci & Paolo Pampanoni

## Exclusive meeting tables

The Italian design of the tables is based on the harmony of straight and curved lines.

## Quality is in the details

The rectangular tables come with soft closing grommet, beautifully framed in metal and concealing the box for wire management. This functional detail becomes invaluable in long meetings.

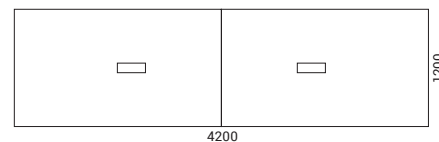
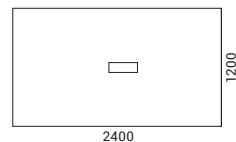
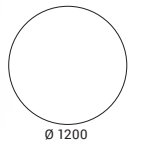

The elegant three-part curved steel legs are crafted using difficult technology and are the ultimate distinctive feature of the system. The solid thick tabletop increases the sturdiness and the visual impact of the tables.





## A universal choice

Intelligently designed solutions allow you to create aesthetically pleasing and well-organized meeting areas.



98

Special desk inserts are functional and playful elements which can be of a different colour than the desktop and can efficiently conceal internet and power boxes. In addition, each cable under the table passes through horizontal and vertical cable ducts.

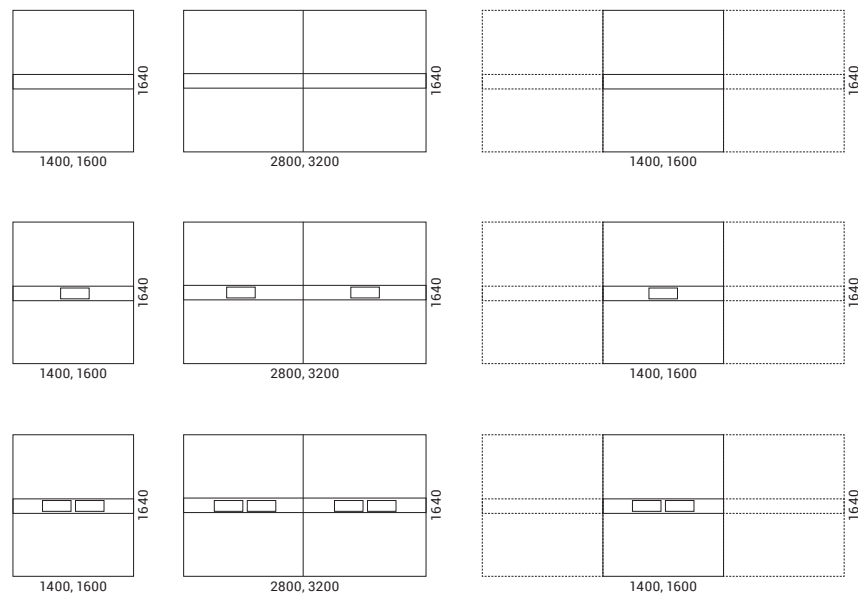

> 68

DESKS

> 118

HIGH  
TABLES

> 124

OCCASIONAL  
TABLES

> 374

EXECUTIVE  
FURNITURE

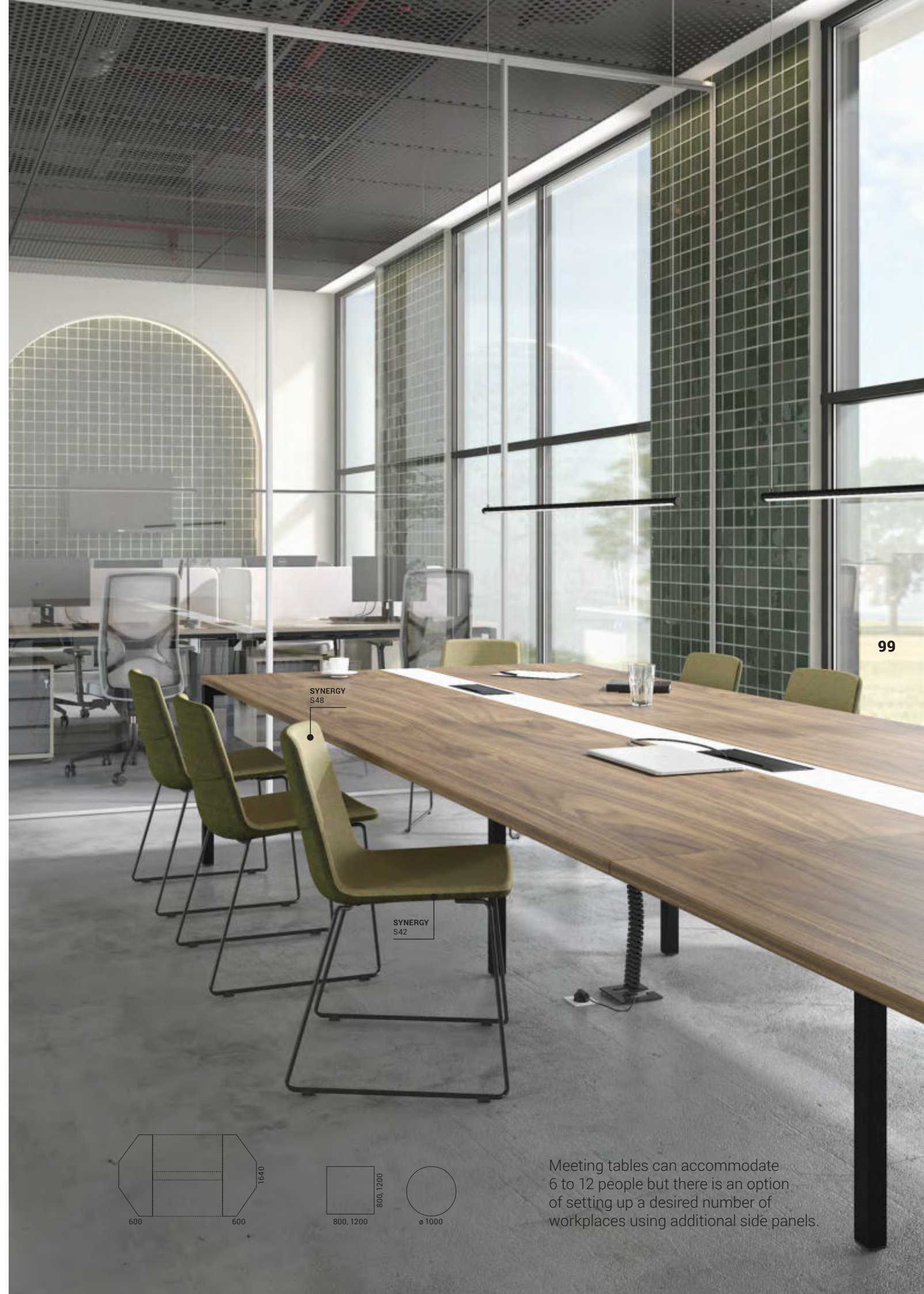

99

SYNERGY  
S48

SYNERGY  
S42

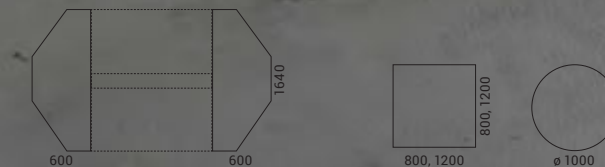

Meeting tables can accommodate 6 to 12 people but there is an option of setting up a desired number of workplaces using additional side panels.



**CONFERENCE  
& MEETING  
TABLES**

# AIR

Design by Gediminas Juška

AIR meeting tables offer a variety of different shapes and capacities ranging from round tables for a few people to rectangular tables which can be joined together to form a large conference space. These tables have an option for hidden cable management so you can keep the tabletop as tidy as possible while charging your laptop or mobile phone.

> 76  
DESKS

> 370  
EXECUTIVE  
FURNITURE

100



The central cover can be removed to reveal a channel that holds accessories and closed for a neat and tidy conference table.

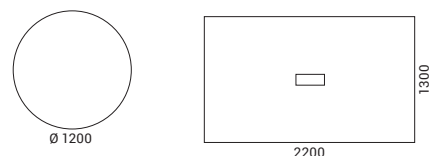

AIR



101

AIR



Let the work flow  
with JAZZ

JAZZ meeting tables are ideal for various kinds of meetings as they are available both as height adjustable and fixed height tables.

102



The design of the height adjustable JAZZ meeting table is unique in that the base of the table is made of concrete. This type of table from the JAZZ line is ideal for short meetings, quick brainstorming sessions or simply enjoyable coffee breaks.

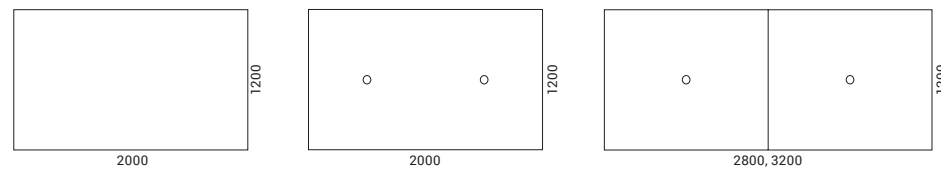

JAZZ



For regular meeting zones accommodating longer meetings, we offer fixed height desks featuring clean lines. These tables are ideal for a team of eight, ten or twelve people.



JAZZ

# FLIP-TOP FLIP-TOP.II

Space-saving  
meeting tables

A FLIP-TOP desk has a desktop that can be flipped up in a vertical position and comes with casters. This will not only enable you to save space but also easily prepare the office space for meetings, conferences, trainings or collaborative work.



104

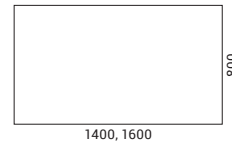

## FOLDING

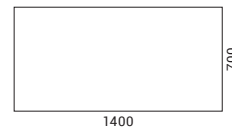

FLIP-TOP / FLIP-TOP.II / FOLDING



105

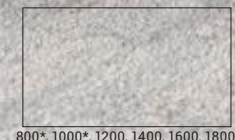

\* - only 600

FLIP-TOP.II



# FORUM

> 125  
OCCASIONAL  
TABLES

Affordable, durable  
and long-lasting  
meeting tables



106

Round tabletops and bases ensure efficient use of the entire table area and facilitate communication with your colleagues and partners. Choose from our extensive range of table sizes to find an option that will offer the most comfort to you and meet your specific needs.

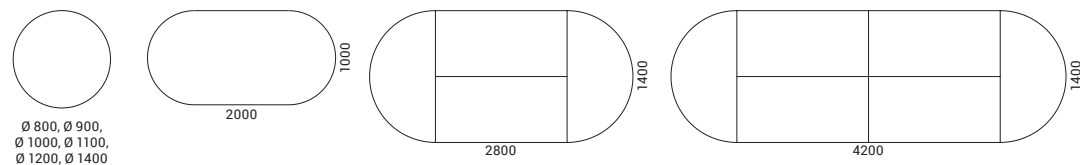

FORUM

# OPTIMA

> 82  
> 83  
DESKS  
> 125  
OCCASIONAL  
TABLES

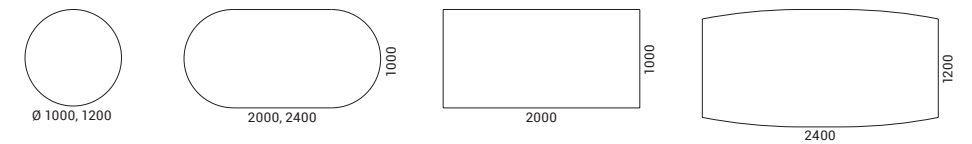

107

# T-EASY

> 80  
DESKS



OPTIMA / T-EASY

# WORKLAB

Design by Baldanzi & Novelli designers

“

*The idea arose from the need to have a dynamic workspace and to break free from orderly office schemes. It has been designed to fit in all those spaces that need to be modified on demand.*

Baldanzi & Novelli designers

108



Make your workspace more dynamic

WORKLAB is a multifunctional piece of furniture that allows you to comfortably use a conference wall, whiteboard, temporary workplace, shelves or make a private space where it is needed the most. Combining all these functions creates a modern and dynamic environment where there is a flow between individual work and team work.

Distinctive design and ensured mobility

This multifunctional piece of furniture was designed by the Italian design studio Baldanzi & Novelli designers. The construction of WORKLAB is based on a metal frame that is robust, durable and easy to clean. Its shape is simple, but also stands out in a traditional work environment. Large castors are an integral part of the WORKLAB design, ensuring the mobility of this piece of furniture and enhancing its unique image.

109



## Power solutions

The cable tray and well-thought-out placement of the power socket and power cord outlet ensure that convenient access to electricity is maintained when changing the WORKLAB's location.

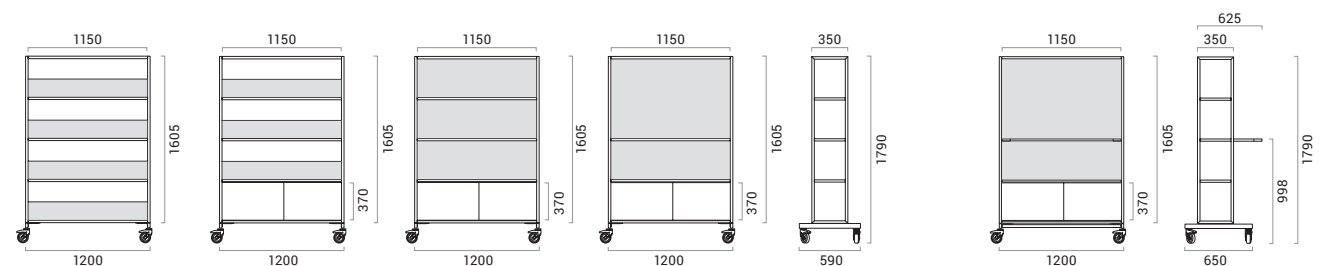



## For user convenience and cosiness

Once you have customised the model that is right for you, you can also order a hook, shelf or side panels for additional functionality. Using these accessories, you will be able to conveniently store things or create more private spaces. They will also become playful design elements in the interior.

110





# MEDIA

A smart solution  
for meeting areas

It gives you an easy way to show presentations and to participate in video conferences and meetings. The conference wall can be attached to various types of meeting tables or high tables. You can also choose MEDIA wall with a power socket and with a cable port for wire management.

112

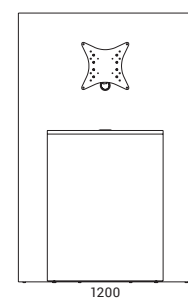
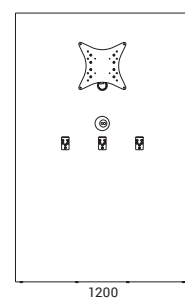
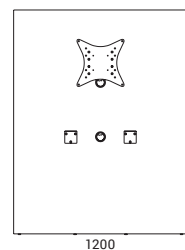
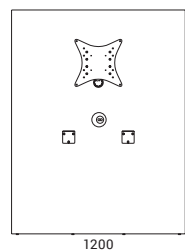



# NOVA

## Wood Multipurpose



114

### Functional accessories and power options

With the help of accessories, you can create a functional and uniquely styled space. You can easily attach a display screen or a writing board to the table legs. Meanwhile, the shelving units will be a perfect place to accommodate water bottles or small office supplies. The office plants placed on top of the shelving units will help to create a more homely and private atmosphere. The electrical solutions integrated into the tabletop will ensure convenient access to power for your meeting equipment.

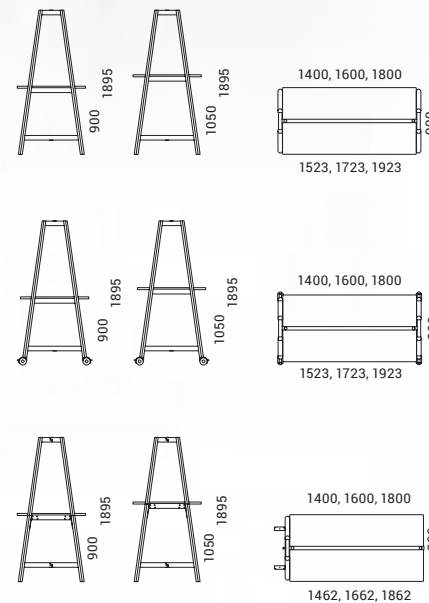

\* Tabletops are also available with cut out for power socket.

> 62

DESKS

> 88

> 92  
CONFERENCE & MEETING TABLES

> 116

HIGH TABLES

> 120

OCCASIONAL TABLES



115



HIGH  
TABLES

# NOVA Wood

A touch of nature  
in your office!

Perfect for spontaneous meetings with colleagues or a short coffee break, the NOVA high meeting table can become a subtle accent and provide your office interior with some extra warmth.

> 62  
DESKS

> 88

> 92

CONFERENCE  
& MEETING  
TABLES

> 114

HIGH  
TABLES

> 120

OCCASIONAL  
TABLES

116



Table height allows you to have a meeting in either sitting position while using high chairs, or standing position which increases the team's engagement, work efficiency, and even health. These tables can also be combined with conference walls, that will let you use multimedia devices while presenting or simply charge your laptop and phone.

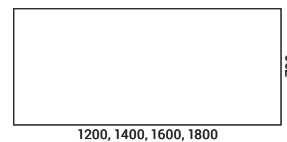
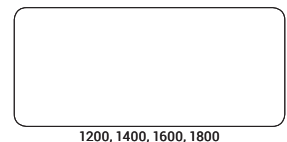

NOVA Wood



NOVA Wood



HIGH  
TABLES

# NOVA

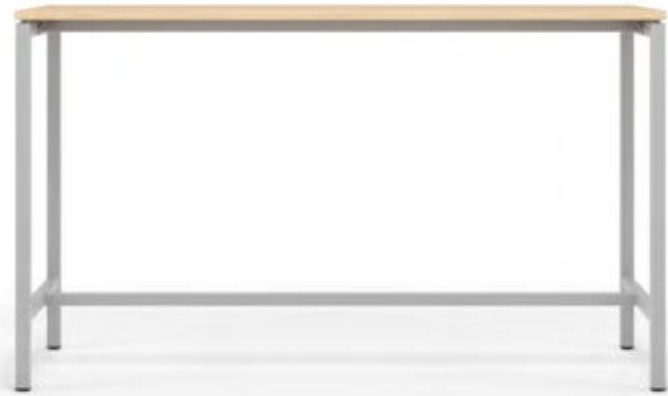

> 68  
DESKS

> 98  
CONFERENCE  
& MEETING  
TABLES

> 124  
OCCASIONAL  
TABLES

> 374  
EXECUTIVE  
FURNITURE

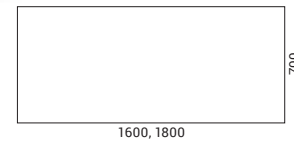

# LIGHT

118

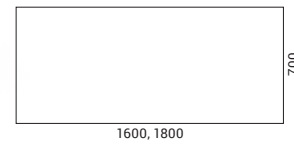

# JAZZ

Design by Christina Strand and Niels Hvass

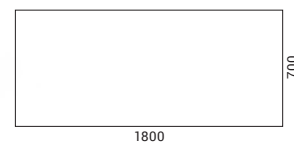
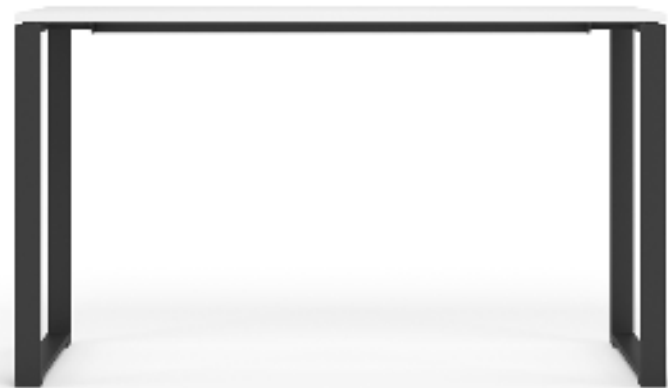

NOVA / LIGHT / JAZZ

HIGH  
TABLES



OCCASIONAL  
TABLES

# NOVA Wood

> 62  
DESKS

> 88

> 92  
CONFERENCE  
& MEETING  
TABLES

> 114

> 116  
HIGH  
TABLES

120



A well-designed and compact addition to any lounge area. These tables come in round and rectangular shapes which will definitely find a place in your interior.

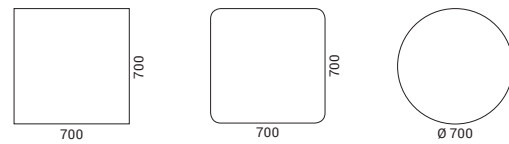

NOVA Wood

OCCASIONAL  
TABLES

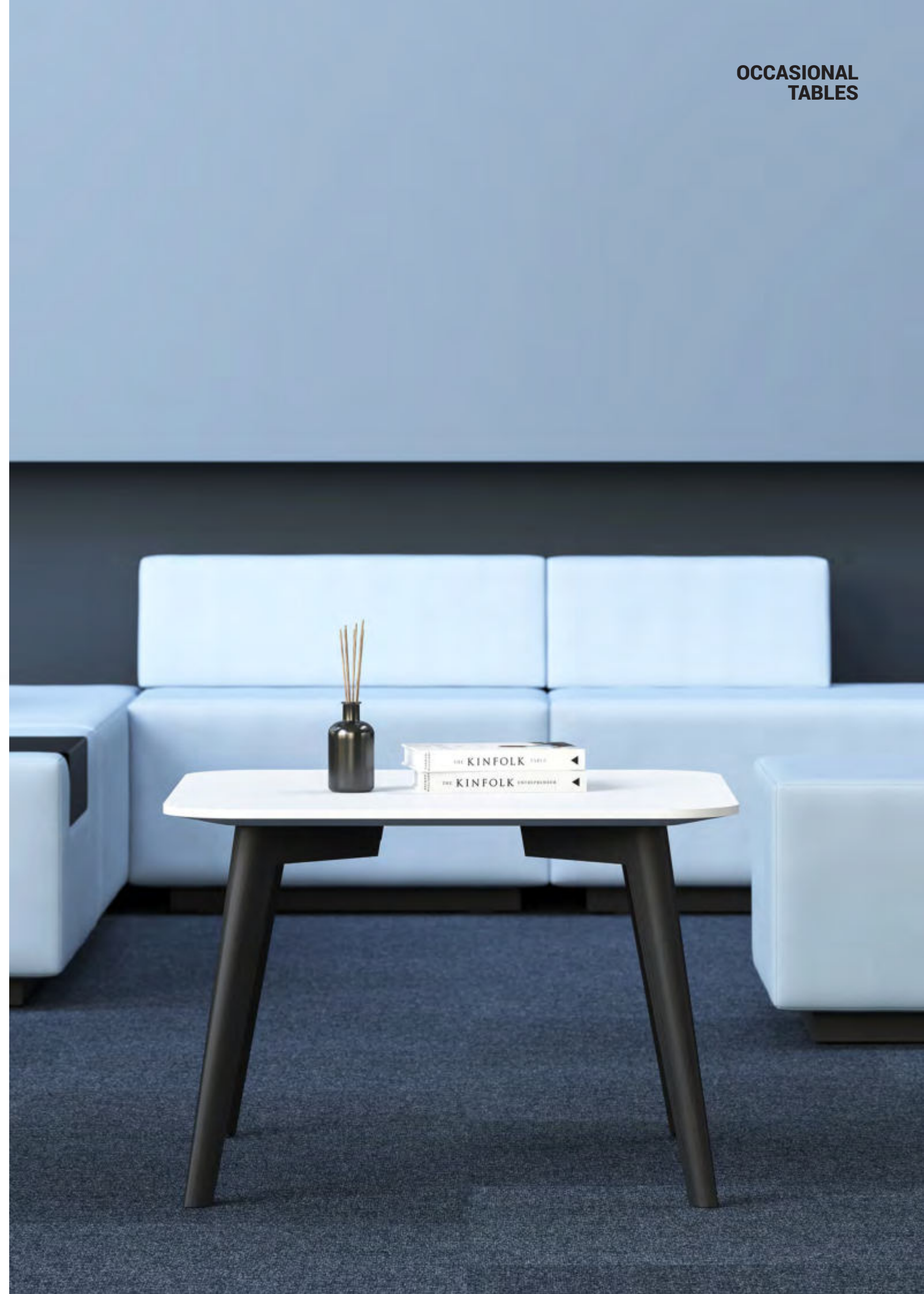



# MOBI

# AMBER



122

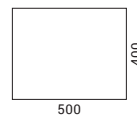

MOBI

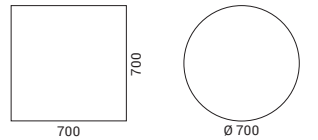

123

# SITO

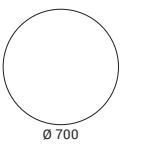

AMBER / SITO

OCCASIONAL  
TABLES

# NOVA

> 68  
DESKS

> 98  
CONFERENCE  
& MEETING  
TABLES

> 118  
HIGH  
TABLES

> 374  
EXECUTIVE  
FURNITURE

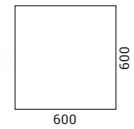

# FORUM

> 106  
CONFERENCE  
& MEETING  
TABLES

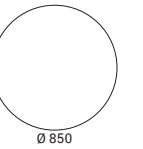

124

# NOVUS

> 82  
> 83  
DESKS

> 107  
CONFERENCE  
& MEETING  
TABLES

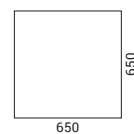

# OPTIMA

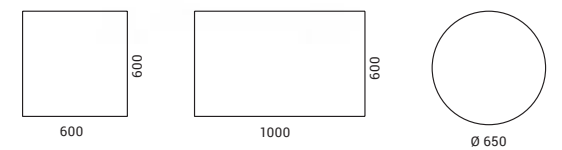



# STORAGE

## CABINETS & SHELVING

---



CHOICE

> 134



COMBUS

> 128

126



UNI

> 142



WORKLAB

> 108



NOVA

> 146

## LOCKERS

---



CHOICE

> 154



NOVA

> 160

## PEDESTALS

---



NOVA

> 162



OPTIMA

> 163

127

## TOWERS

---



BOXI

> 150



# COMBUS

More than  
just a shelf

COMBUS is a modular shelving system that not only serves the function of a traditional shelf, but is also a good solution for shaping and dividing spaces. It consists of different types of shelving, which are designed to be placed in an open space, against a wall or on top of cabinets. The COMBUS collection has all the key features required to become an essential part of the modern office, where different types of spaces are intertwined – it is functional, has an easily adaptable design and is environmentally friendly.



128



129





Different options for different needs

The COMBUS shelving system consists of freestanding shelving units, planter shelf units, shelving units for mounting on cabinets. This shelving system can be used in the middle of a space, against a wall or shaped as a corner.



130



Shelving units for mounting on cabinets – ready-made configurations

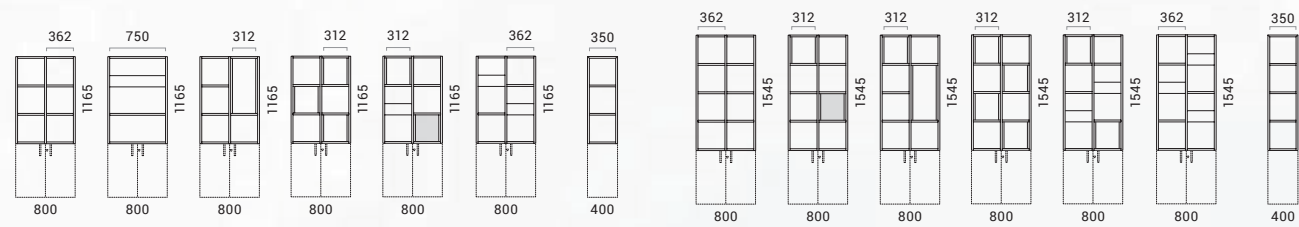
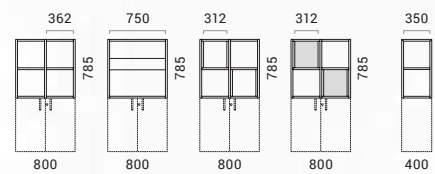

Shelves

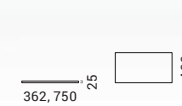

Open and closed shelf boxes

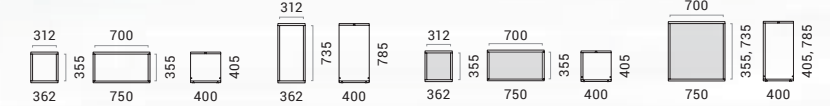

Planter boxes

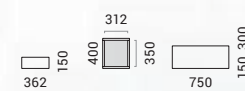

Cabinet with drawer



Shelving units – modular configurations

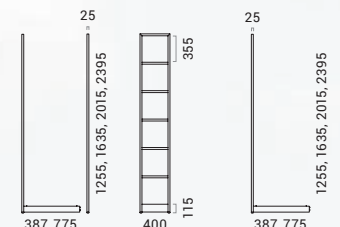

Planter shelf units – ready-made configurations

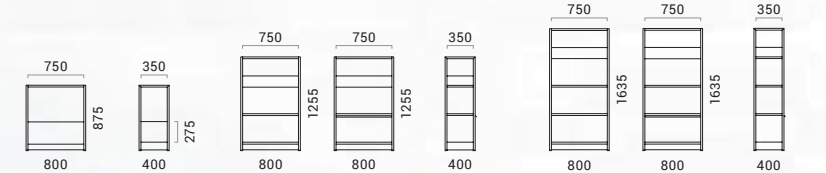





132

133



Your freedom of choice!

We offer a wide range of storage solutions and functionality thus you will be able to select or create customized cabinets best suited for your office space.

134



135

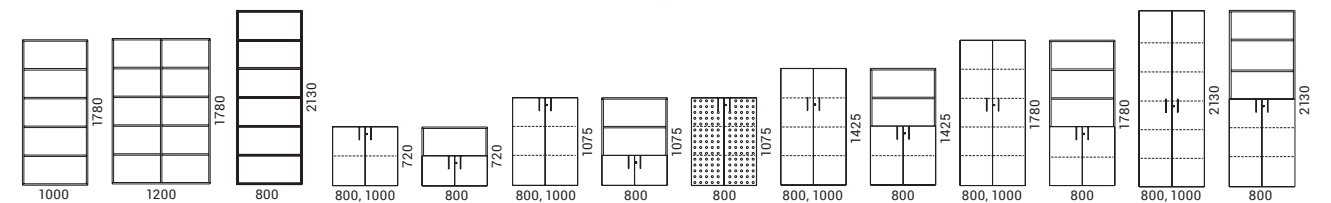
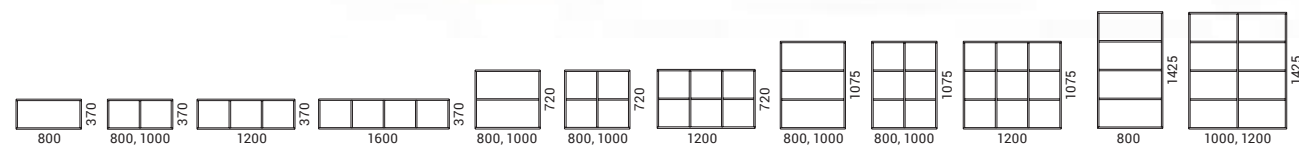

**CABINETS & SHELVING**

Wide array of cabinets

The system of cabinets offers a choice from as many as 6 different cabinet heights, 4 options of doors and widths, and even 7 different types of bases. Enjoy a complete freedom to choose the one that suits you best!

You can use acoustic doors, cabinets with sliding doors, cabinets with hinged doors and open bookcase storage.

136

Metal baseboard or metal legs will be perfect for those who want to create a minimalist office style. Legs made of natural ashwood will bring you closer to nature in a very subtle manner. Castors will make it easy to rearrange office furniture. Each solution can be your best choice.

4 door types



Open book cases    Hinged doors    Sliding doors    Acoustic doors

**CABINETS & SHELVING**

6 heights



4 widths



7 base types



## Practical approach

One of the greatest advantages of CHOICE storage units is that they offer a convenient and practical internal layout.

## Endless combinations

You can easily create your own unique design by combining different cabinets. Also, a good idea is to combine different types of textures: tapestry, melamine and natural veneer. Choose from a wide range of materials and colors to create desired combinations that will blend nicely into your office.

138

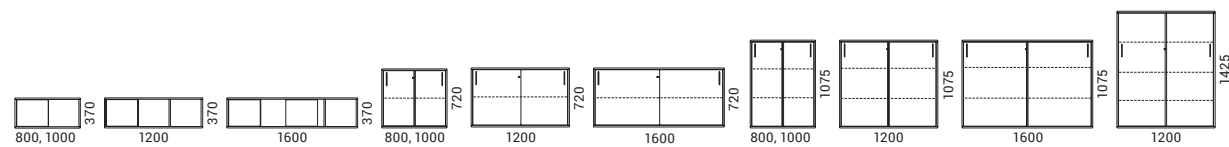

CHOICE

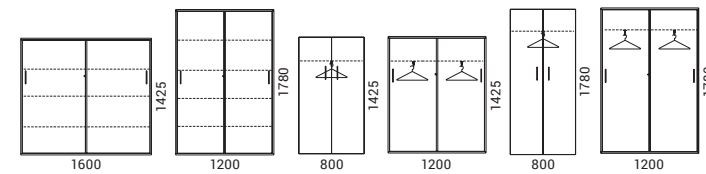

CHOICE







## Well-organized storage of office materials

A large selection of accessories allow you to arrange the inside of the cabinets based on your individual needs.

142



143

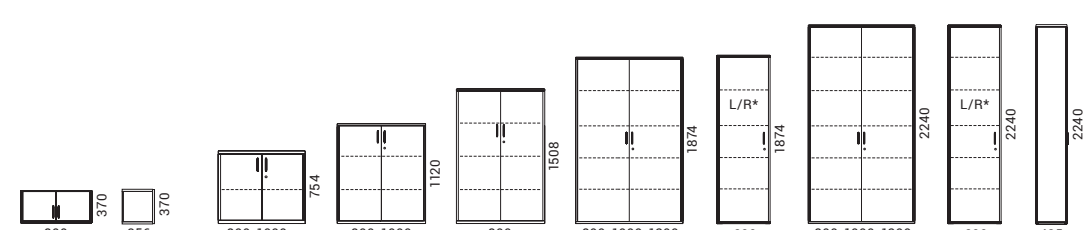
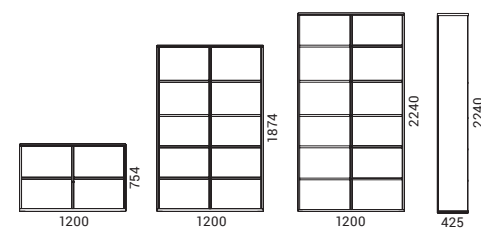
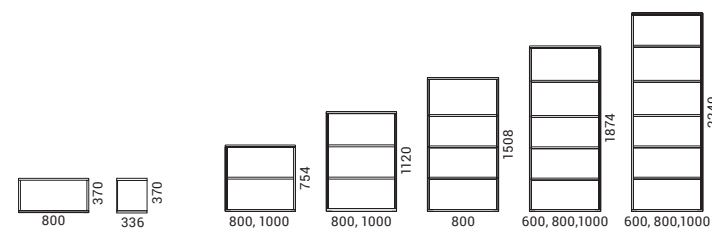
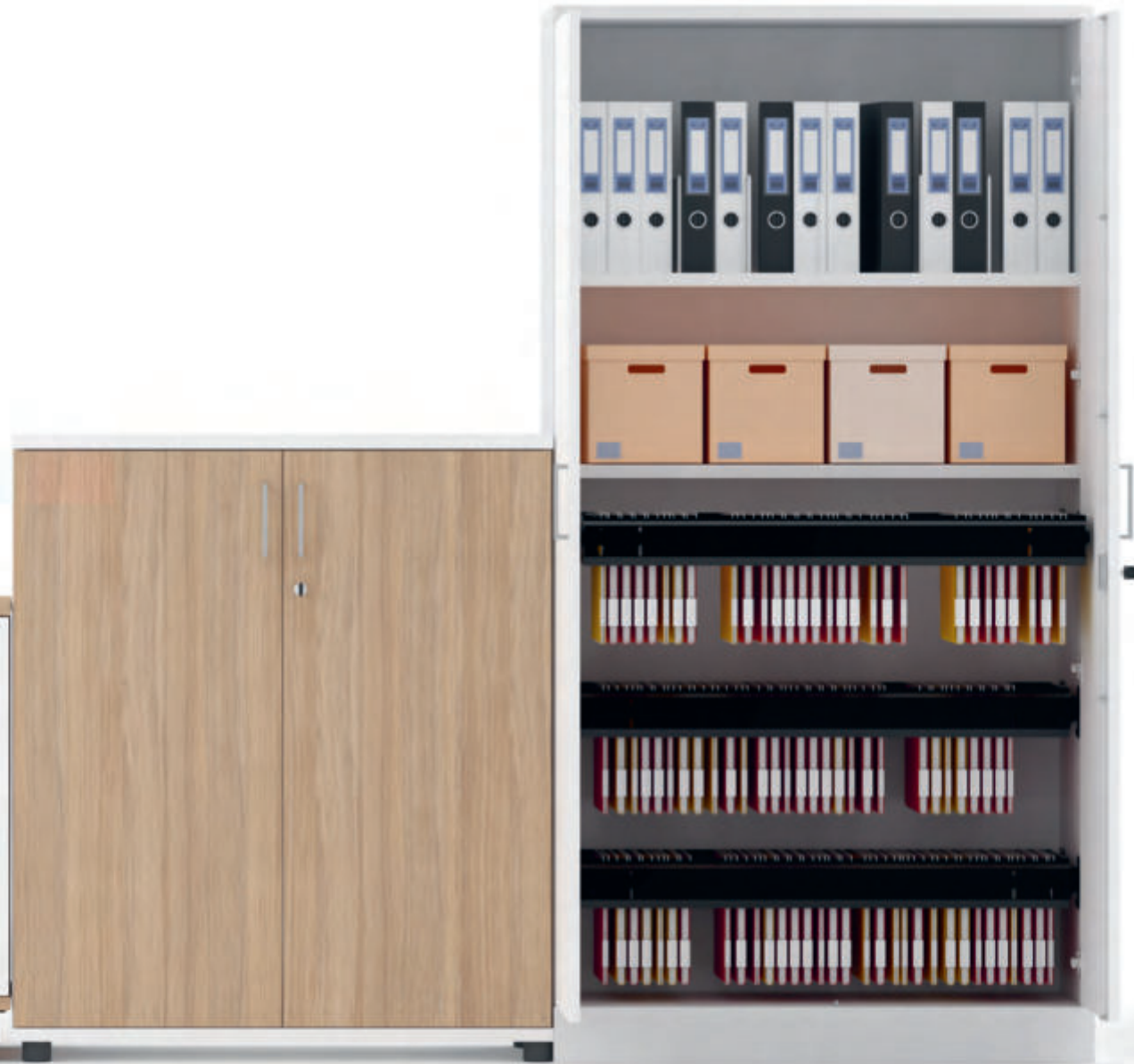

\* - left/right

## Colourful details

An upholstered back of the cabinet adds colour to your office space and absorbs noise. If you choose a cabinet with a special back suitable for writing on it, you will have an additional space to capture your ideas.

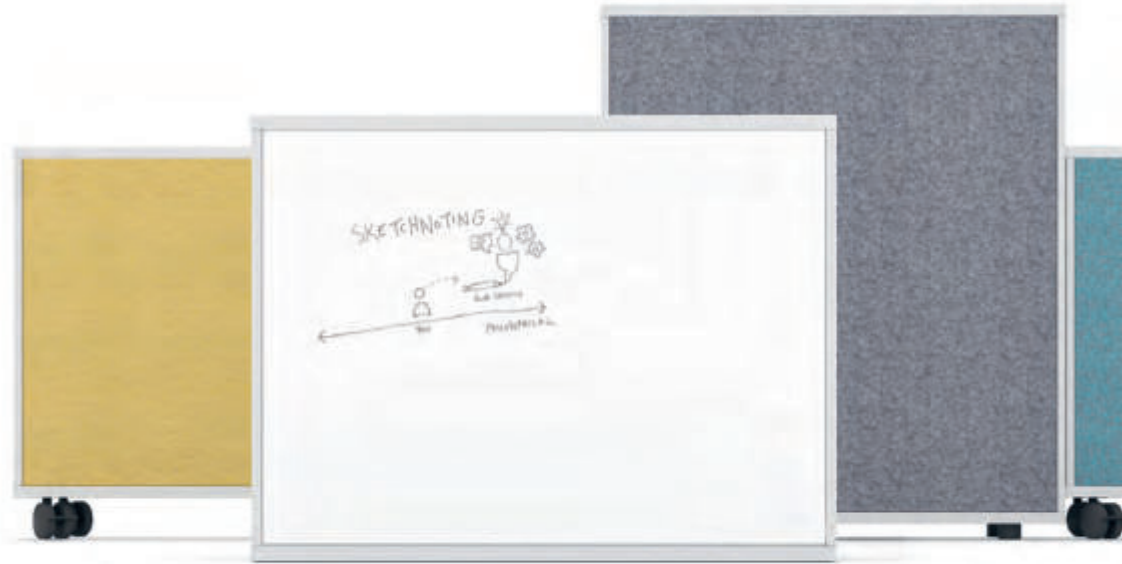

144

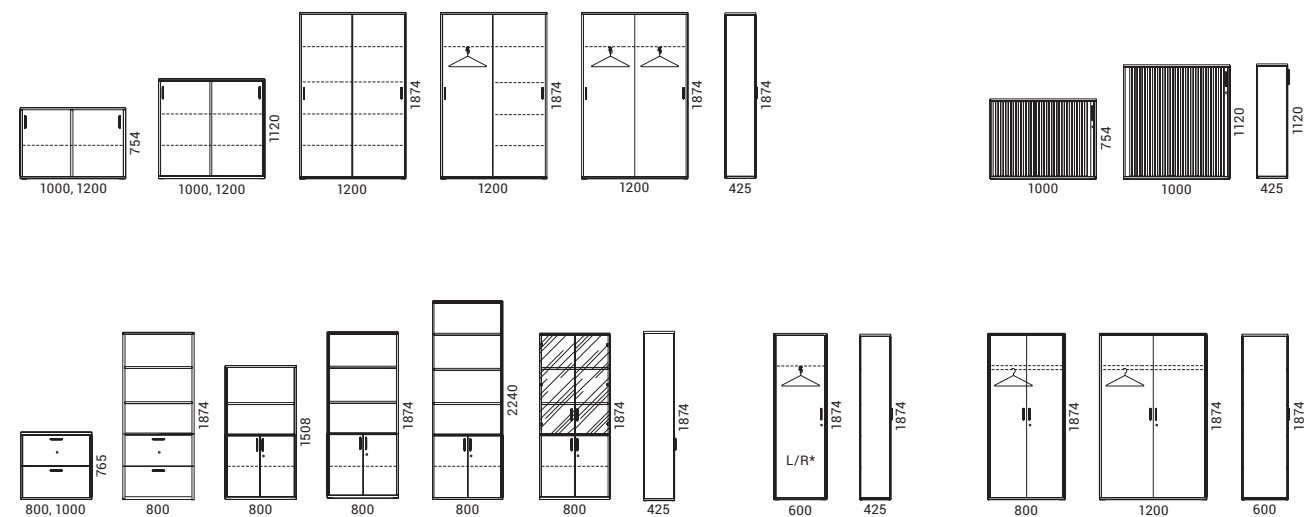

\* - left/right





Wonderful simplicity

Simple and ergonomic solutions are ideal for setting up large office spaces and help to create a coherent interior style.

146



147

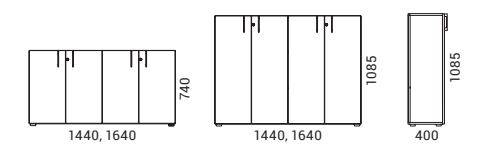
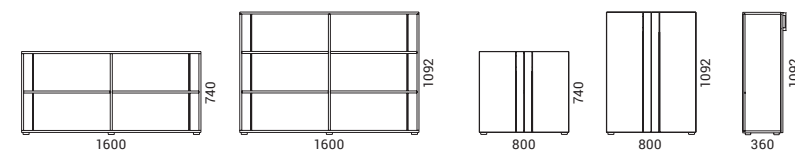
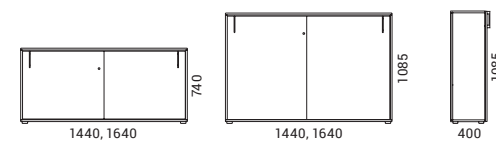
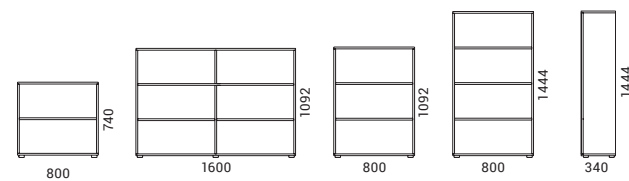
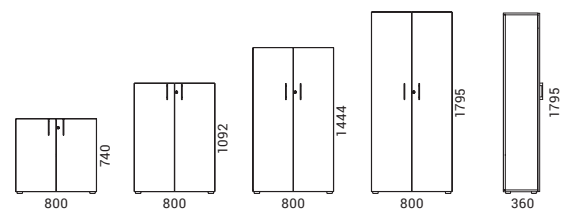

**CABINETS & SHELVING**

Adapted to desk height and depth

The height and depth of the cabinets match the bench desks available in the product line.



148

Decorative elements

Choose decorative Plexiglas inserts and handles for your cabinet to add a nice touch to it.



NOVA

**CABINETS & SHELVING**





# BOXI

Minimalist style – unlimited possibilities

BOXI storage tower is a simple and universal solution designed to accommodate all office essentials for the daily needs in the office.



150



BOXI

Flexible arrangement of work spaces

Choose a preferred tower height: a 740 mm storage tower can serve as an extension to a fixed-height desk, whereas 1090 mm or 1200 mm options will be a great addition to the sit-stand desks or can be used as a workspace divider. BOXI storage towers with shelves can have either right-hand or left-hand configuration thus they can be easily re-arranged if you decide to change the workspace layout.

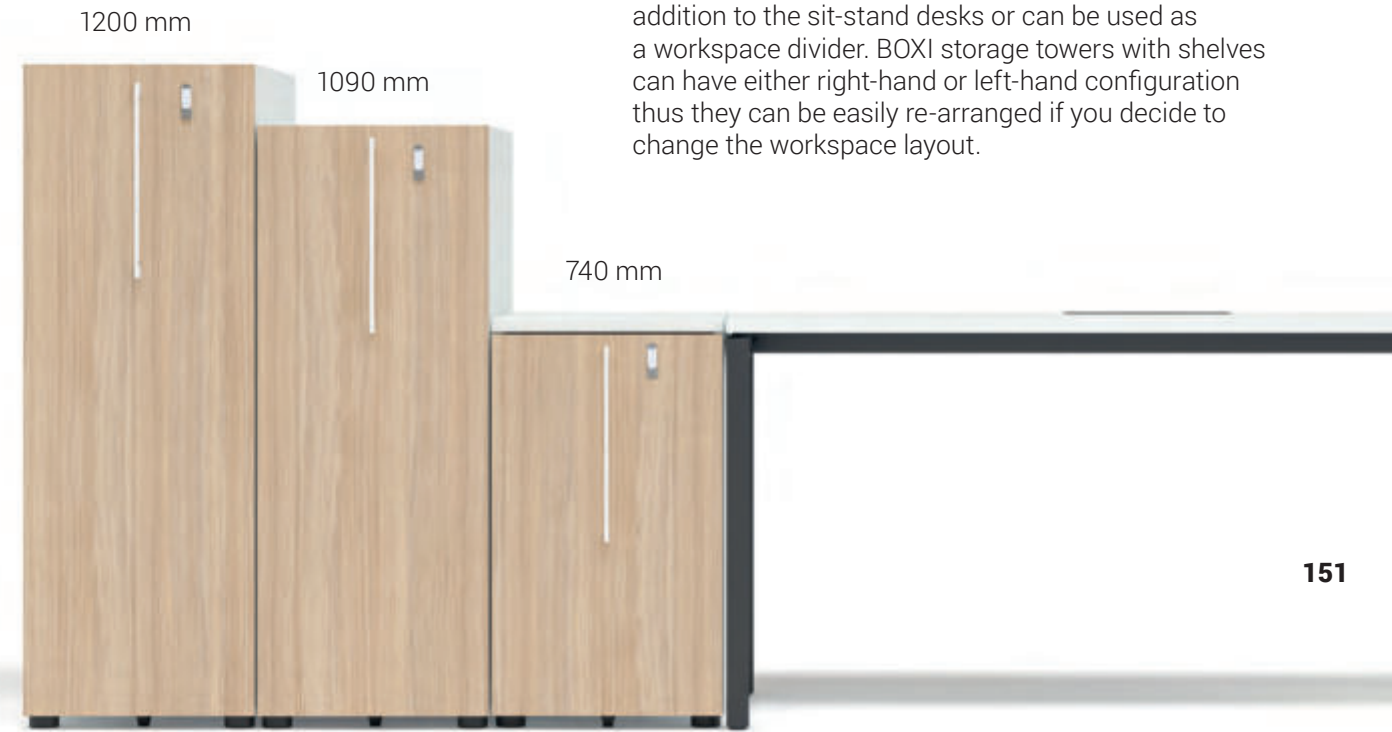

151

All storage towers are available in two depths of 800 mm or 820 mm, thus they can be combined with single desks or bench desks.

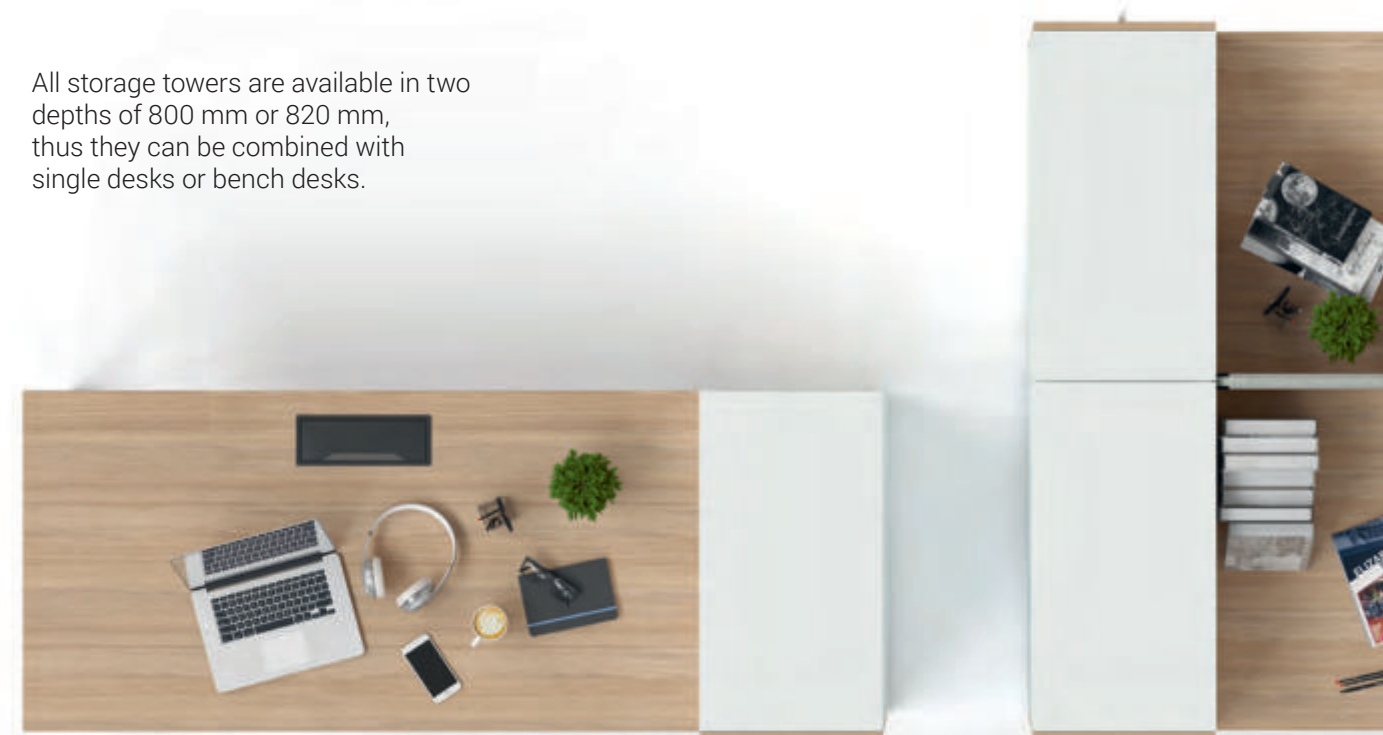

BOXI



## TOWERS

Make the most of all available options

Choose spacious shelves or universal file drawers, small shelves with an upholstery lining or small drawers for storing small items. BOXI storage towers with USB or plug sockets will allow you to charge your mobile devices.

152



## Visual versatility

Mix and match various melamine covers or use a planter box to transform the BOXI storage towers into green islands with flourishing greenery which will be a great way for employees to rest their eyes during a break.

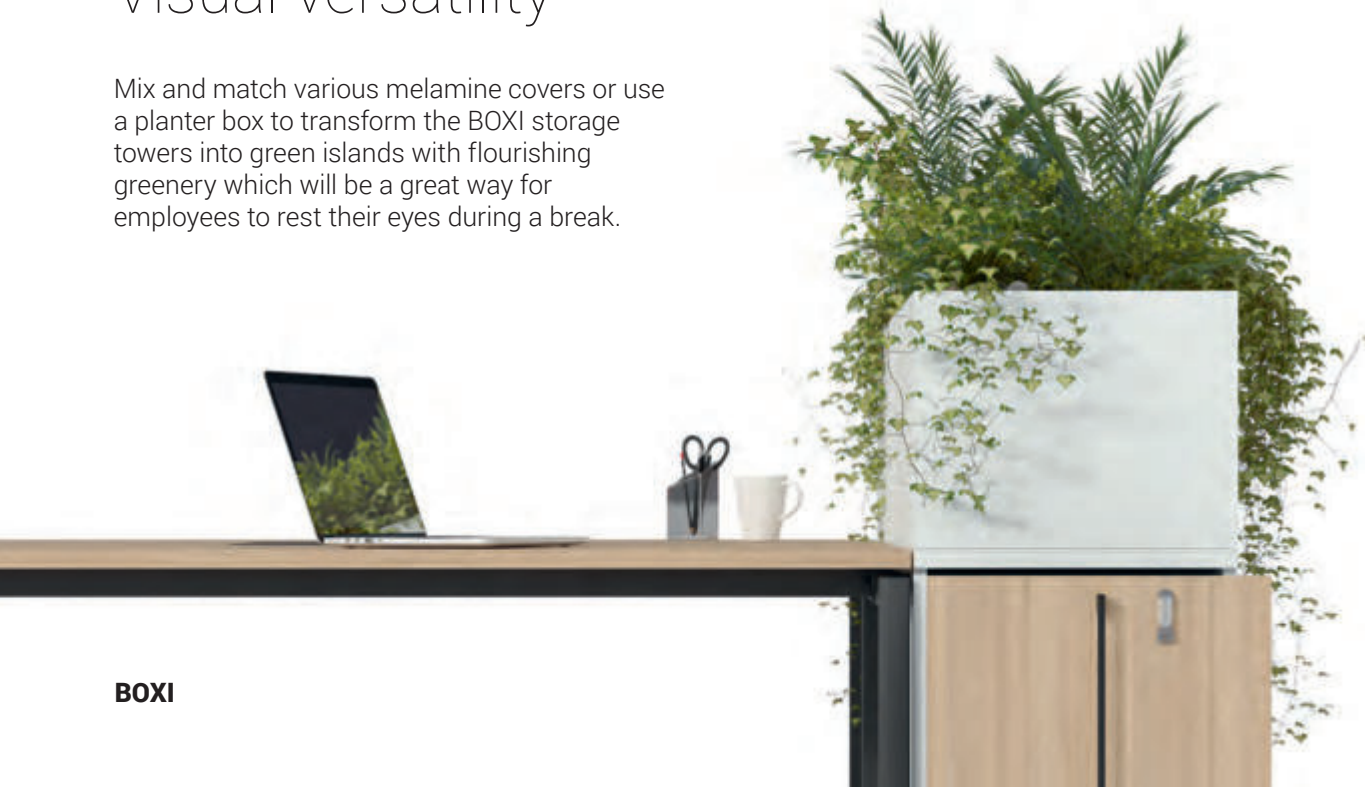

BOXI



BOXI



## Essential attribute for shared spaces

Modular locker cabinets are a versatile solution for secure personal and office items storage, temporary or all-day use. CHOICE lockers can be useful for both resident and mobile workers or office visitors.

154

## Modular system

Create the most suitable combinations for various spaces by combining CHOICE locker modules of the same height (917 mm / 1367 mm / 1817 mm). Also, you can combine doors of two heights (450 mm / 900 mm) and different types – the standard and with cut-out for mail or air circulation.



155

## Personalized lockers

A variety of sizes and box types fulfils different needs – from storing small personal and work tools to big-size items. Customize your locker by using additional items such as metal shelves, name card holder or hook for clothes.



## 4 types of locks

Along with the traditional key locking, we offer also a combination lock and electronic locks (opened by a code or a card). Lockers with electronic locks can be assigned for personal use or be used by different users for temporary needs.

## Colourful combinations

Locker is a great tool to express your company's culture. It could be the place where you add brand colours to your office space.

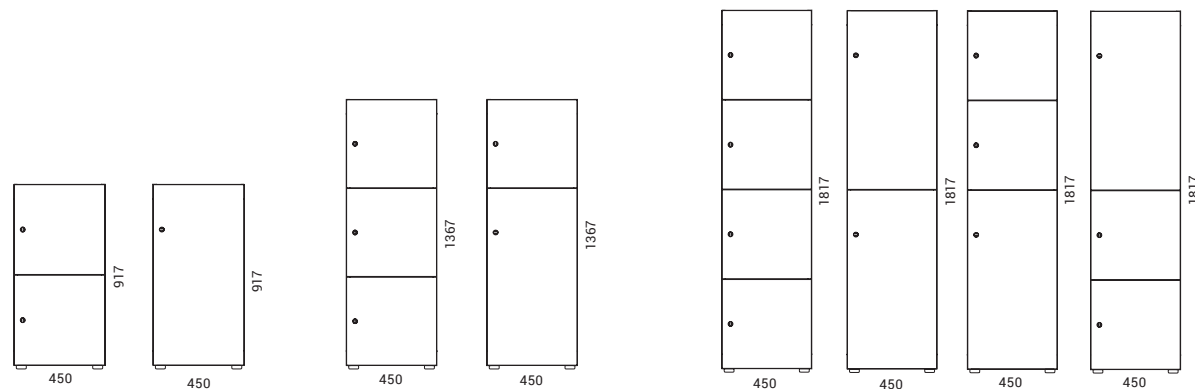

CHOICE

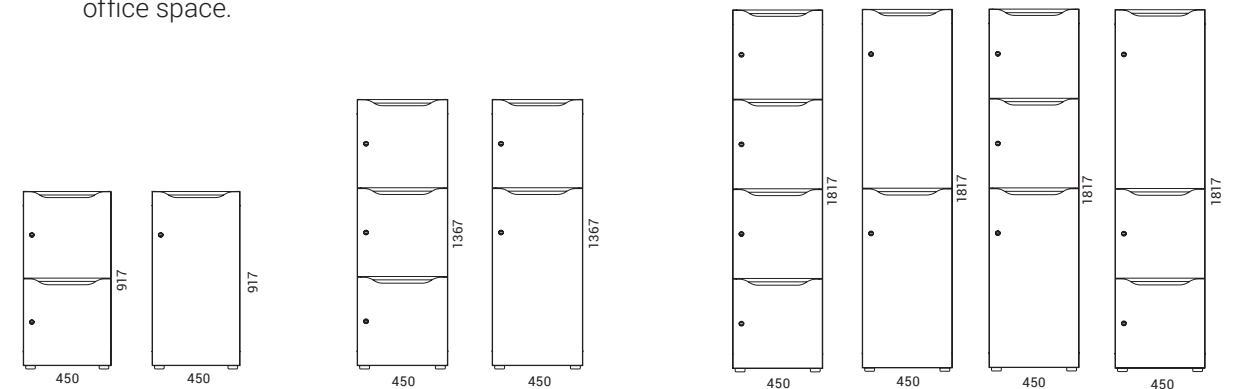

CHOICE





CHOICE

CHOICE



LOCKERS

# NOVA

> 146  
CABINETS &  
SHELVING

> 162  
PEDESTALS

A privacy feature  
for any workplace

NOVA is a simple and cost-effective storage solution. With heights of both 1092 mm and 1444 mm, these lockers feature either 6 or 8 compartments. Each compartment is lockable for keeping personal items secure. Locker doors and carcasses are available in a range of Melamine finishes which allows you to easily fit this furniture to the desired office design.

160

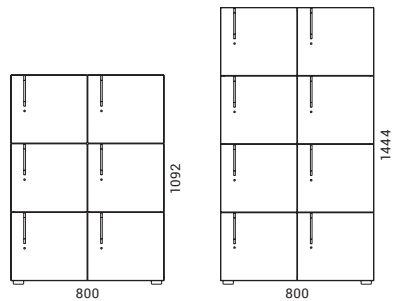

NOVA

LOCKERS



NOVA



# NOVA

> 146  
CABINETS &  
SHELVING

> 160  
LOCKERS

## Universal storage cabinets

We offer suspended cabinets, mobile under-desk cabinets or fixed desk-height cabinets. Cabinets can come with conventional drawers or hanging file drawers.

162



## Customizable design

Design options featuring minimalist handles or no handles allow you to create a neat and "clean" office space. You can also add a playful touch to your workplace by combining different colours of doors or cabinet frames or by incorporating a cushion so that employees could take a seat on the cabinet for a short rest break.

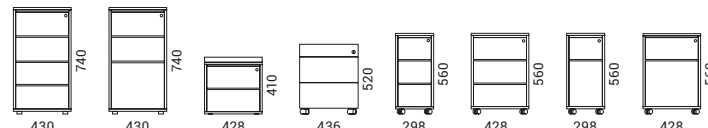

# OPTIMA

## Essential furniture for every workplace

OPTIMA pedestals will definitely expand your workspace and provide convenient storage for files and small items. You can choose from desk height, under desk or mobile pedestals based on your needs and preference. Clear design and high functionality will make OPTIMA pedestals a great addition to any personal working area.

163

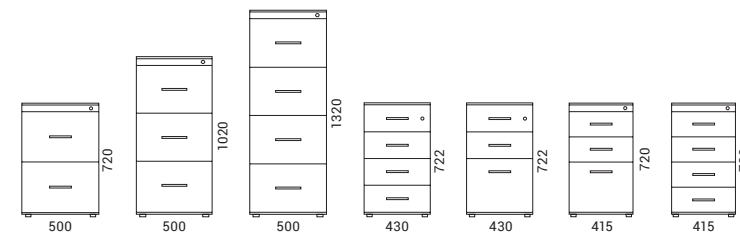

# ACOUSTIC SOLUTIONS

## ACOUSTIC PODS



**SILENT ROOM**  
> 166

164

## ACOUSTIC FURNITURE



**JAZZ Silent Box**  
> 200



**MY SPACE**  
> 204



**ARCIPELAGO Wood**  
> 210

## ACOUSTIC SCREENS & PANELS



**FREE STANDING**  
> 174



**MODUS**  
> 178



**MODUS Light**  
> 180



**ACOUSTIC ARTWORK Partitions**  
> 182



**ACOUSTIC ARTWORK Tiles**  
> 184



**ACOUSTIC ARTWORK Clouds**  
> 186

## ACOUSTIC DESK SCREENS



**ZEDO PET**  
> 188



**ROUND PET**  
> 190



165

**MODUS**  
> 194



**DESK 760**  
> 196



**TOP 530**  
> 198



# SILENT ROOM

Choose SILENT ROOM acoustic pods to create functional work areas by dividing or opening interior spaces as necessary. This piece of furniture can be set up in the middle of the office space, near the walls or partitions or inside a wall niche maintaining a clearance of just 300 mm at the top for air circulation.

## S

## M

## L

## XL

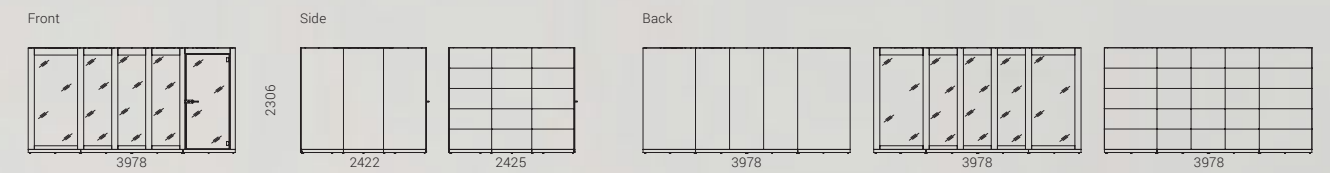
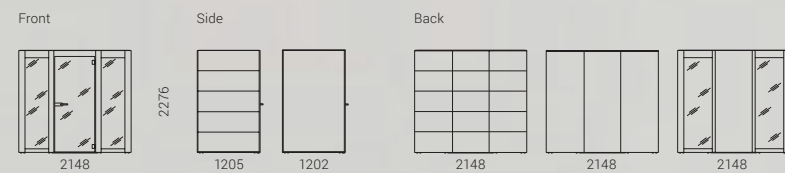
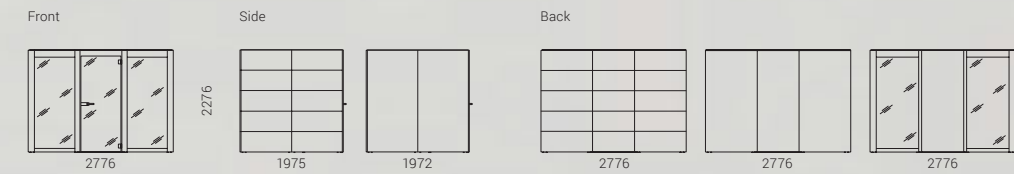
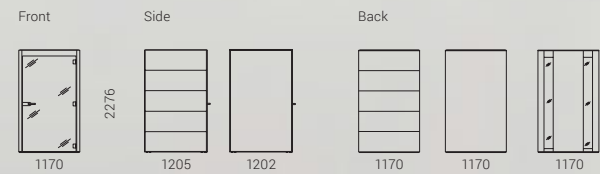
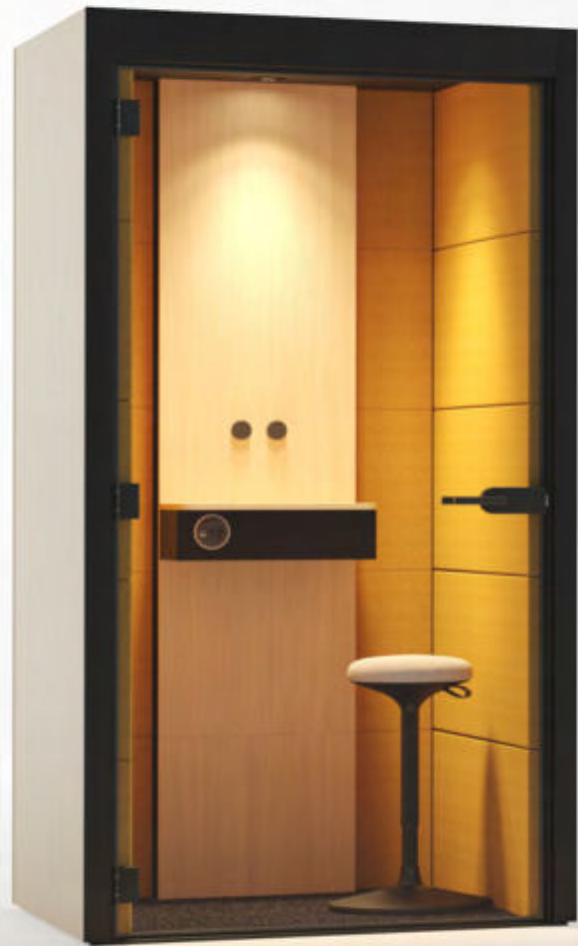

## Less noise, less chaos

Multilayered SILENT ROOM wall structure, hermetic door and ceiling ensure sound insulation. The inner layer of the panels is made from high-class acoustic material that eliminates echo and has excellent sound absorption properties. The upholstered exteriors block out noise effectively and create an acoustically-optimized working environment.

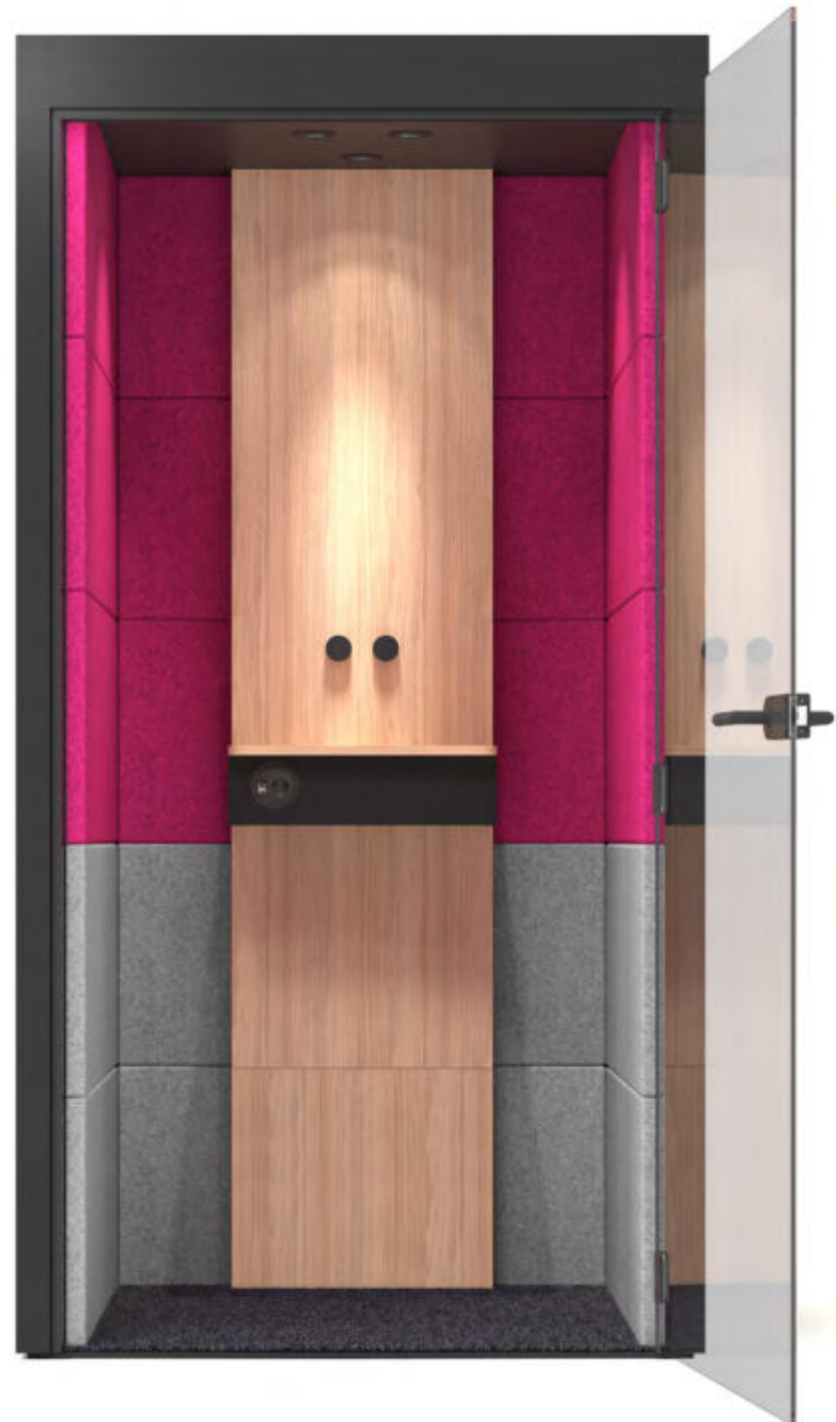

168

## Creative freedom to customise your design

SILENT ROOM offers a variety of design options for you to be able to create a personalised design and desired office mood. The interior and exterior finish can be selected separately. Both melamine and upholstery can be used for the exterior panels.



169

A powerful ventilation system installed at the floor level and in the ceiling of the SILENT ROOM acoustic pod efficiently removes excess heat and high levels of CO<sub>2</sub> concentration. A smart control unit selects an optimal ventilation and illumination level, and, if necessary, allows for individual adjustment. Once an employee leaves the SILENT ROOM, intense ventilation is automatically activated to prepare the room for the next user.



**ACOUSTIC  
PODS**

SILENT ROOM is easily adapted to a variety of activities. The acoustic pods come in three different sizes with selectable options such as glass back-wall inserts, high or standard tables, seating, monitor holders, etc.

For users' convenience, the room can be equipped with a power outlet (USB type A and C connectors) or 3-plug power block. The power block can come with in-built sockets, LAN or USB ports in various configurations.

**ACOUSTIC  
PODS**

**SILENT ROOM**







# FREE STANDING

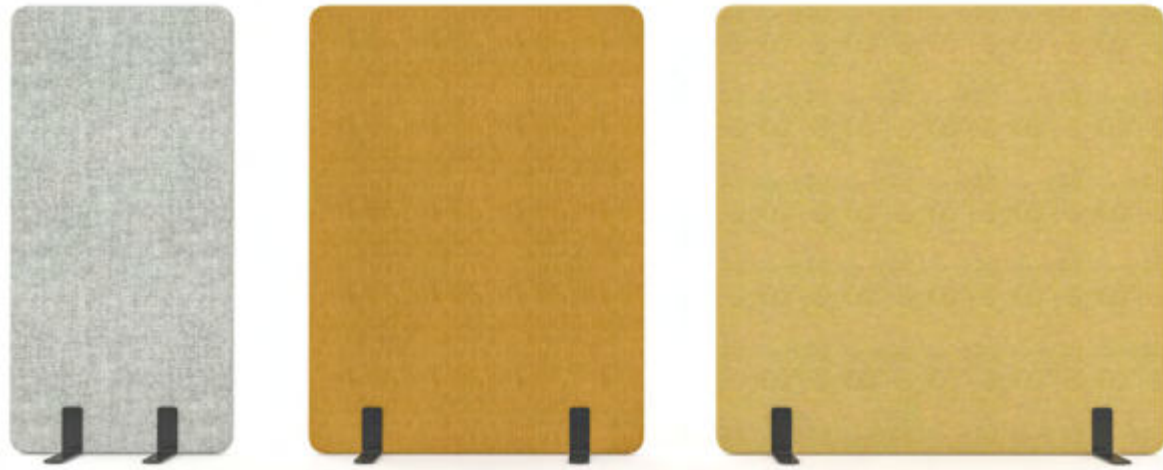

174

## Multifunctional acoustic screens

FREE STANDING acoustic screen system offers unlimited possibilities to divide your office with visual and acoustic barriers and even quickly create new areas for specific types of activity.



FREE STANDING





**ACOUSTIC  
SCREENS &  
PANELS**

**ACOUSTIC  
SCREENS &  
PANELS**

Thanks to their simple configuration, these acoustic screens allow you to easily divide your office space into desired areas. You can choose free standing screens with support feet or mobile screens on casters. The panels are available in a broad selection of sizes and can also serve as workspace dividers.

The screens are filled with a special sound-absorbing foam and provide a class C sound absorption. They can be upholstered with the fabric of your choice. The special connectors can be used to combine, align and hold the screens in place.

176

177

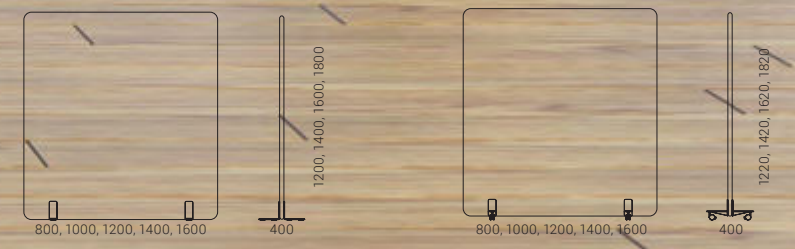

**FREE STANDING**

**FREE STANDING**



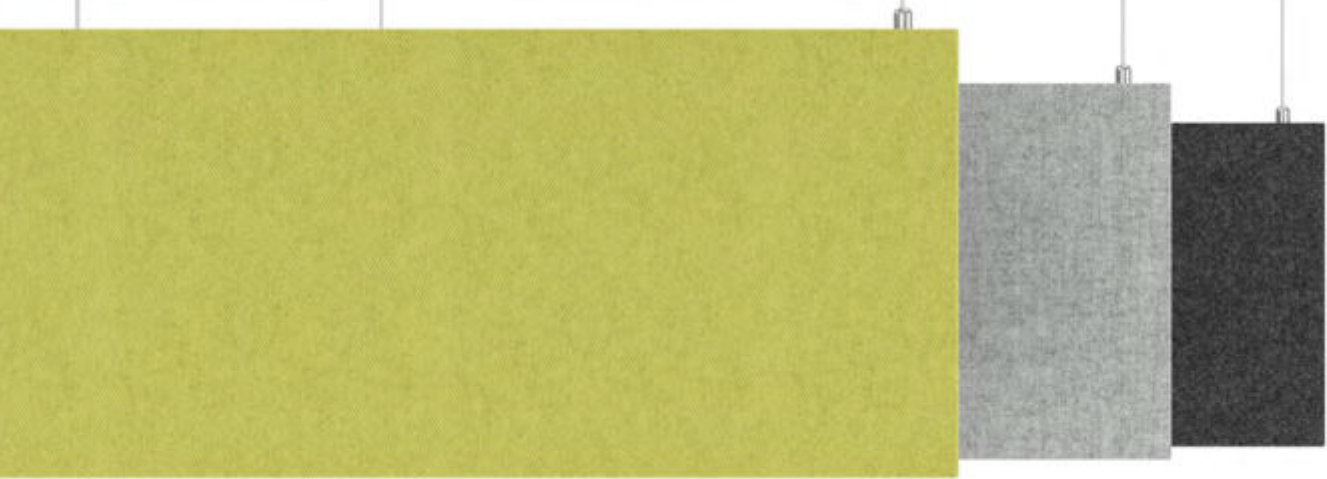

178

MODUS acoustic panels will improve your working environment and workplace well-being by absorbing background noise and by creating acoustically private spaces as well as bringing character to the interior space. The acoustic panel system includes wall panels, ceiling (horizontal) panels, and ceiling (vertical, double-sided) panels.

The panels come in different sizes, as large as 1200x1200mm, and are very easily joined together. The panels contain a special patented and certified material designed to efficiently absorb sound.

Double-sided (vertical) panels

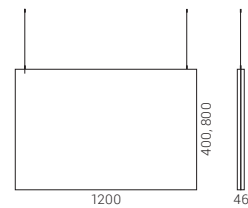

Wall panels

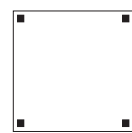

Ceiling (horizontal) panels

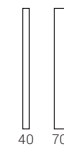
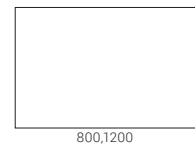

You can choose acoustic panels with different fabric colours on each side to create your own unique interior design. Select from from six different sizes and mix and match different panel depths (40 or 70 mm).



# MODUS Light



180

## Acoustic comfort in open-plan offices

MODUS Light are lightweight, sound-absorbing wall and ceiling panels that improve office acoustics and serve as an inspiring and functional interior solution.

Panels are made of acoustic foam offering class A (for a 68 mm panel) or class C (for a 48 mm panel) sound absorption.

Thanks to their lightweight design, these acoustic panels are easy to transport and easy to install. MODUS Light are available in three design options: wall and ceiling panels, hanging panels, and Armstrong ceiling panels (integrated or hung on a wire rope). The panels have multiple different fitting options and can be attached to a number of surfaces, even glass.

Implement your creative ideas by using acoustic panels of three different sizes and two different depths. You can also choose from our wide range of fabrics and a variety of colour options.

Acoustic panel with metal fittings to be fixed to suspended ceiling "Armstrong"

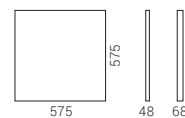

Wall panels



Ceiling (horizontal) panels

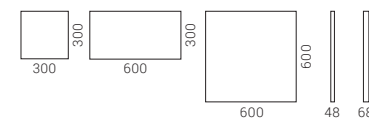



# ACOUSTIC ARTWORK Partitions

> 184

> 186

ACOUSTIC  
SCREENS &  
PANELS

A creative solution  
for dividing spaces

ACOUSTIC ARTWORK product range includes acoustic products made from PET felt and designed to improve room acoustics. Besides improved acoustics, these products are also ideally suited for performing other functions: dividing and creating office spaces, and designing a unique interior.

182

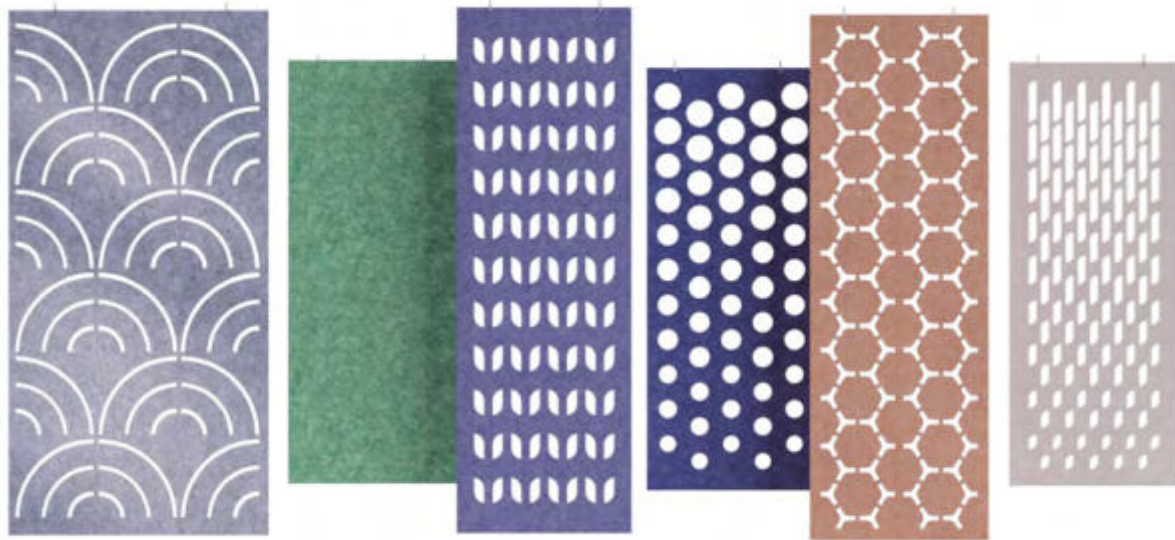

Wide array of  
patterns and  
colours

Choose your favourite partition design and colours and set up unique office spaces which will be both visually and acoustically pleasing for your employees.

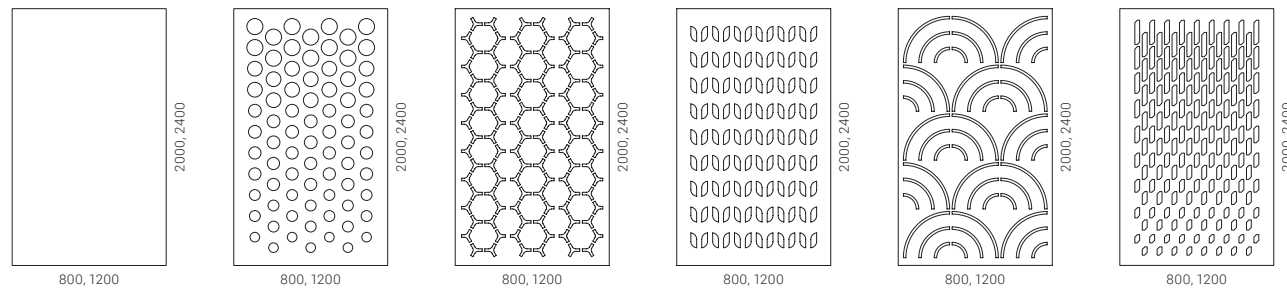



# ACOUSTIC ARTWORK Tiles

> 182

> 186

ACOUSTIC  
SCREENS &  
PANELS

Panels that create  
acoustic comfort

Just like other ACOUSTIC ARTWORK products, "tile" type panels absorb some ambient sounds, noticeably reduce reverberation and add a sense of acoustic comfort to your space.

184



Wide range of  
applications

Our acoustic panels are ideally suited as decorative elements for a variety of different office spaces: the walls of work areas and lounge zones or corridors and niches which serve as oases of peace and quiet for relaxing or performing tasks that require some level of concentration.

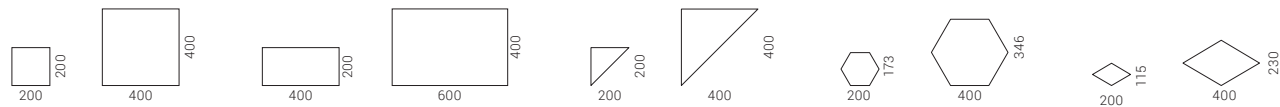

## Walls that speak for themselves

Acoustic panels which come in five different shapes and a selection of sizes will unleash your creative side. ACOUSTIC ARTWORK Tiles will add a lively touch to your office walls and will help you shape the image of your company.

PET felt  
B19

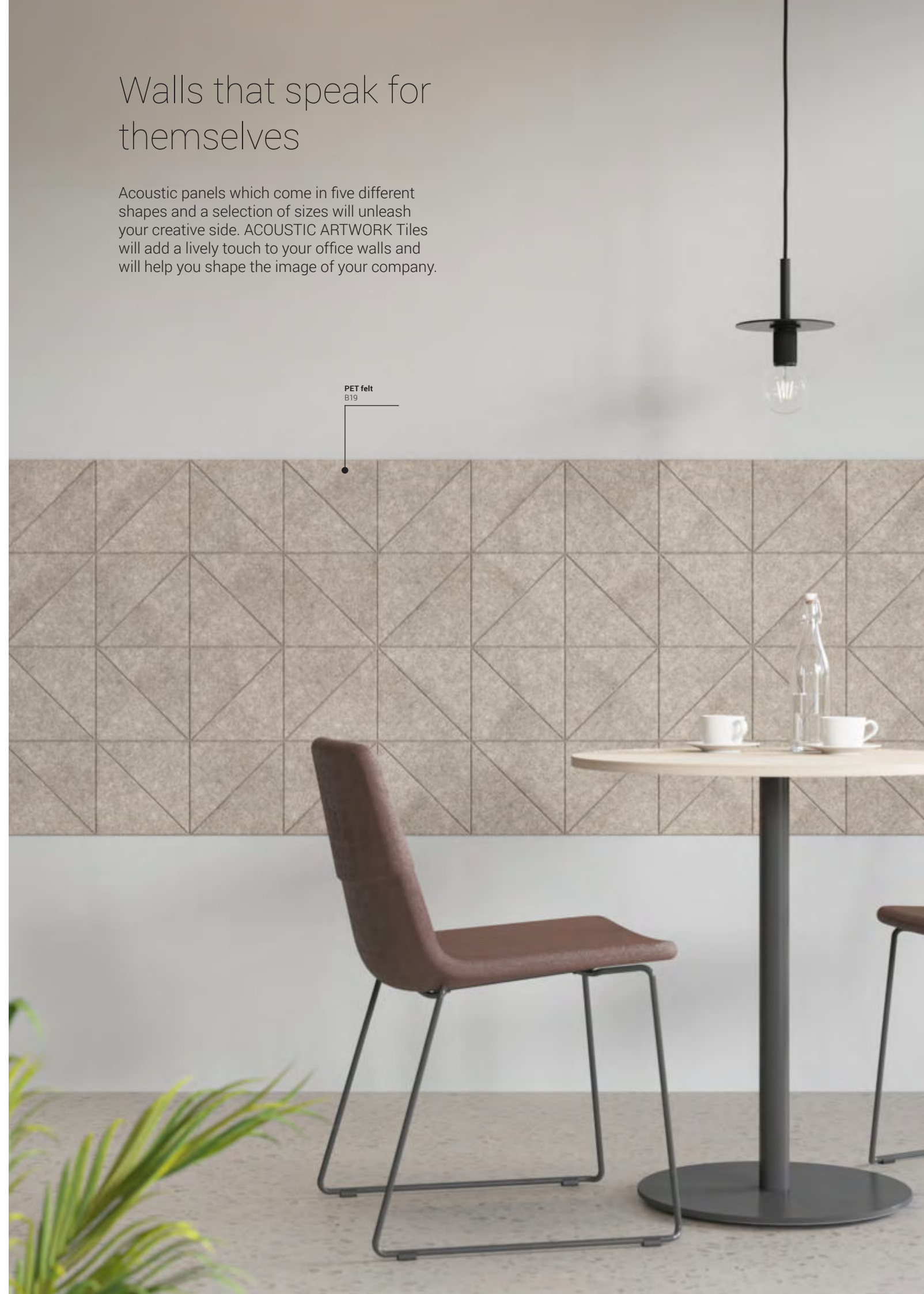



# ACOUSTIC ARTWORK Clouds

> 182

> 184

ACOUSTIC  
SCREENS &  
PANELS

Acoustics  
from above

ACOUSTIC ARTWORK Clouds are a ceiling solution that improves office acoustics. With the help of these acoustic elements, you will be able create an acoustically comfortable environment for both work and relaxation.

186



A unique  
interior detail

The ACOUSTIC ARTWORK Clouds are sure to attract attention thanks to their shape. Choose your desired colour and this acoustic product will serve as a unique interior design element for your office.

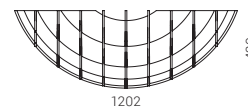
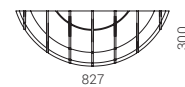



# ZEDO PET

Design by Paolo Pampanoni

ZEDO PET are exclusive acoustic screens which are integral part of a modern, aesthetic and comfortable workplace.

## Thoughtful design

Non-typical felt sheet bending totally hides its supporting structure, while the extended edge covers the cable tray and wires. This way a workplace looks neat and aesthetic.



188

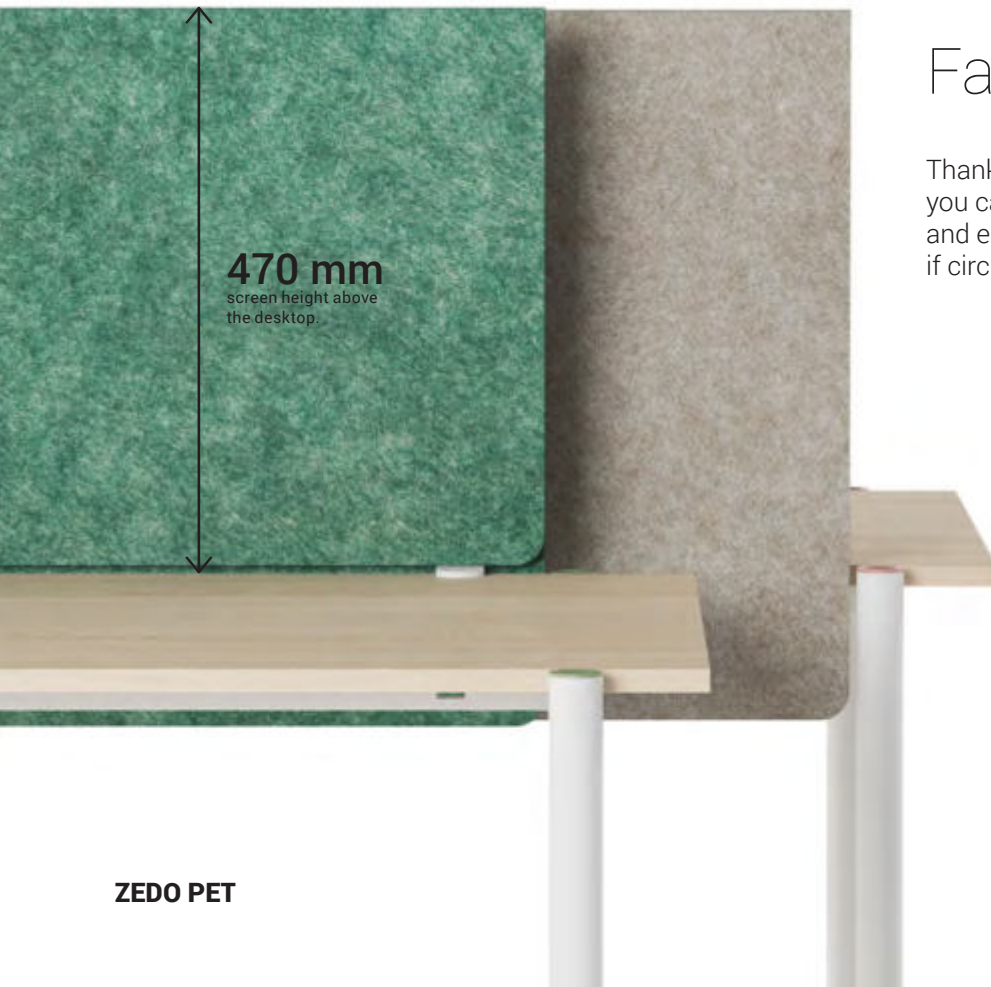

470 mm  
screen height above  
the desktop.

ZEDO PET

## Fast assembly

Thanks to the ZEDO PET screen holders, you can assemble your screen quickly and easily, and disassemble and relocate if circumstances change.

## Playful accessories

A magnetic board and a shelf for small objects or plants can be attached to the screen if necessary. Functional metal accessories echo the colour combinations of the ZEDO desk system. Distinctive accessories add a unique and playful touch to your workplace. Also, they are a very suitable tool to personalize your workplace.



PET felt  
B19

189

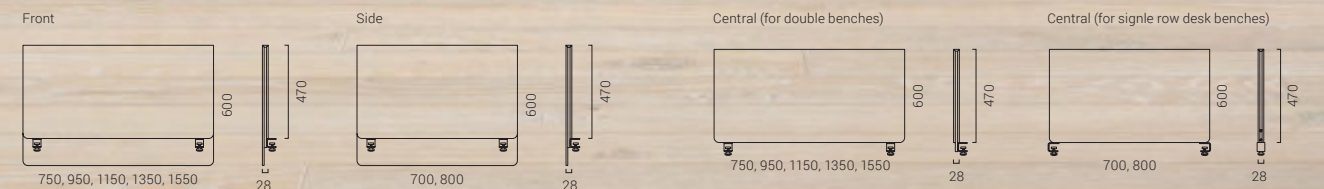
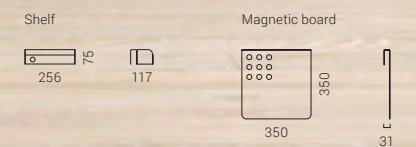

ZEDO PET



# ROUND PET

A sustainable solution for acoustic comfort and privacy

ROUND PET acoustic desk screens are an excellent solution to ensure a greater level of privacy and acoustic comfort for employees, while at the same time giving them sufficient freedom to share their ideas with other team members. The product encourages circular economy as it is made from recycled materials and it is also suitable for recycling.



190  
530 mm  
screen height above the desktop.



330 mm  
screen height above the desktop.

## PET felt features

This sustainable material possesses excellent sound absorption properties. PET felt is soft and light, yet strong and durable material is ideal for desk screens. Due to the structure PET felt can be easily cleaned and disinfected.

SCREEN PATTERN TYPES

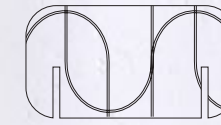
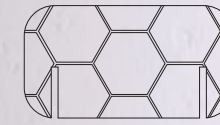

SCREEN TYPES

For fixed desktops

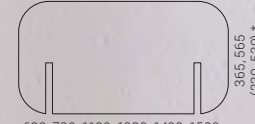

680, 780, 1180, 1380, 1420, 1580, 1620, 1780

Mobile

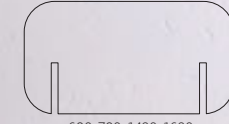

680, 780, 1420, 1620

For sliding desktops



1180, 1380, 1580

\* - screen height above the desktop

## Rounded design sequel

ROUND PET acoustic screens are a part of ROUND desk system. Therefore, they share the rounded shapes as the main design element.

PET felt  
B56



191



ACOUSTIC  
DESK  
SCREENS





## Privacy and comfort at the workplace

Height-adjustable or fixed-height MODUS acoustic desk screens will offer both privacy and sound absorption sheltering users from general office noise.



194



MODUS

MODUS acoustic desk screens are double-sided. Thanks to this construction, you will be able to choose a combination of two different colours.

Height-adjustable screens will allow you to adjust the height of these acoustic screens by releasing and tightening the metal holders. Choosing a fixed-height will ensure a uniform look of the workspace even with one employee standing and another sitting at the desk.

The screens provide Class D sound absorption. Class C sound absorption is available for MODUS desk screens specifically designed for our MOTION two-desk benches.

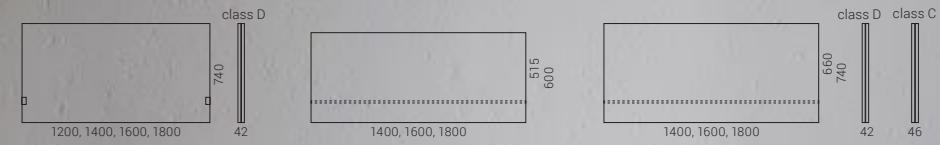

Height adjustable screens suitable for desk systems:  
ACTIVE, single MOTION desks, single EASY desks, ONE, NOVA A, T-EASY, ONE H.

Screens suitable for MOTION bench desks with leg columns type 2.  
515 mm - screen height above the desktop.

Screens suitable for MOTION bench desks with leg columns type 3.  
660 mm - screen height above the desktop.



MODUS



# DESK 760

## Privacy without isolation

The DESK 760 acoustic panel system improves visual and sound comfort of the workplace without separating team members from one another thus allows them to communicate freely. The system offers screens to cover all sides of the desk. Thanks to a wide range of colour options and functionality, these panels work well in various spaces.

196



DESK 760

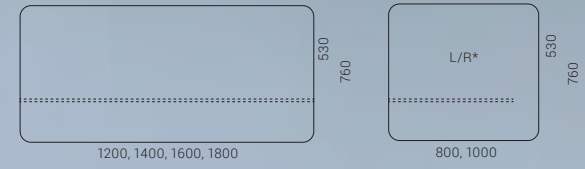

Screens suitable for desk systems:  
NOVA U, NOVA H, NOVA A, NOVA O, EASY,  
T-EASY, ONE, ACTIVE, AIR, NOVA Wood  
(Melamine; only single desks)

\* - left/right



DESK 760



## Acoustic comfort and privacy at the workplace

TOP 530 acoustic desk screens add privacy to your workplace and absorb background office noise. This solution enables employees to better focus on their tasks yet still allows communication and doesn't separate team members from one another. The system offers screens to cover all sides of the desk.

Because of the sound-absorbing material TOP 530 acoustic desk screens have a class C rating for sound absorption. The screens are perfect for both single desks and bench desks and come in a variety of colours and materials to match any interior.

198

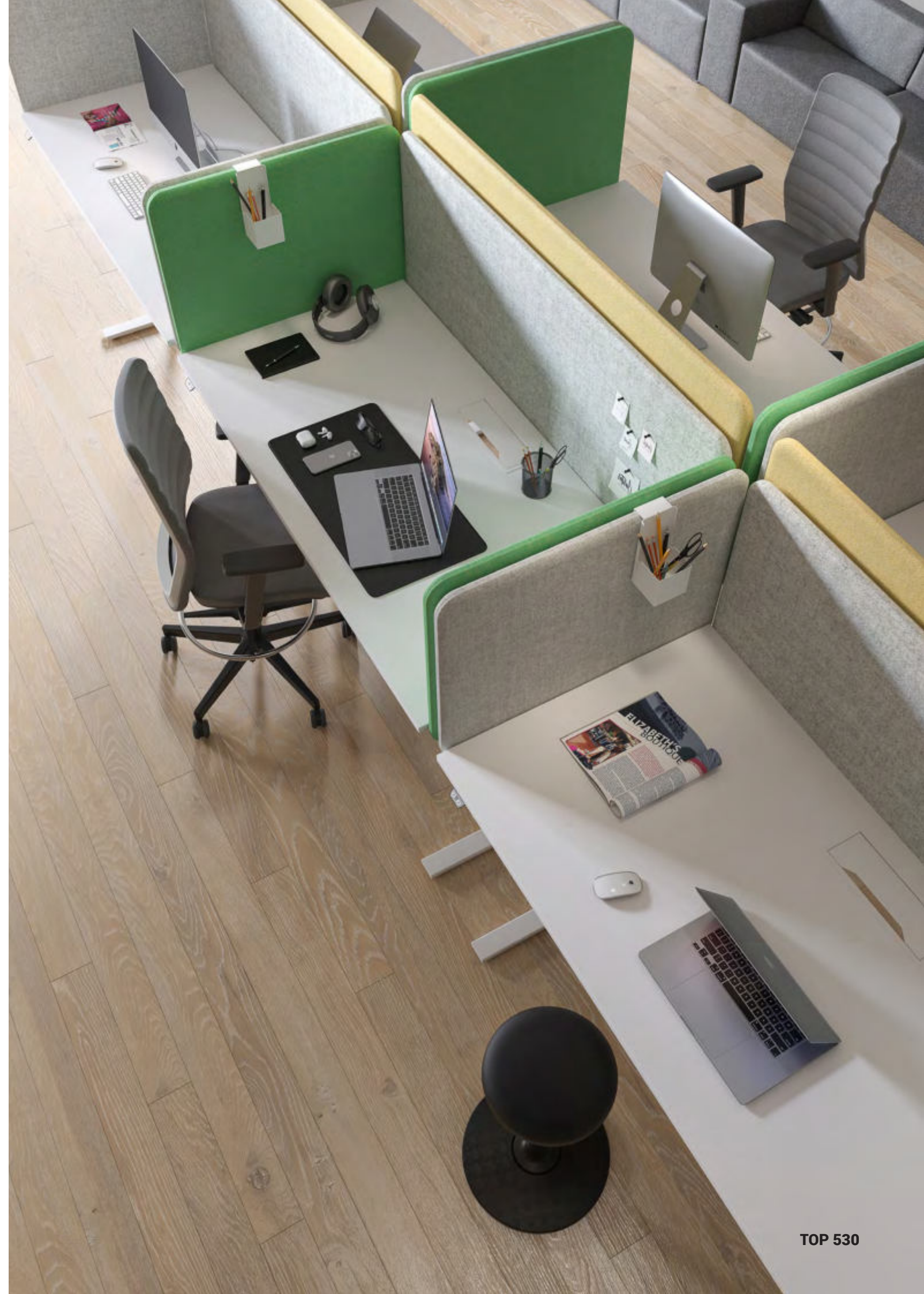
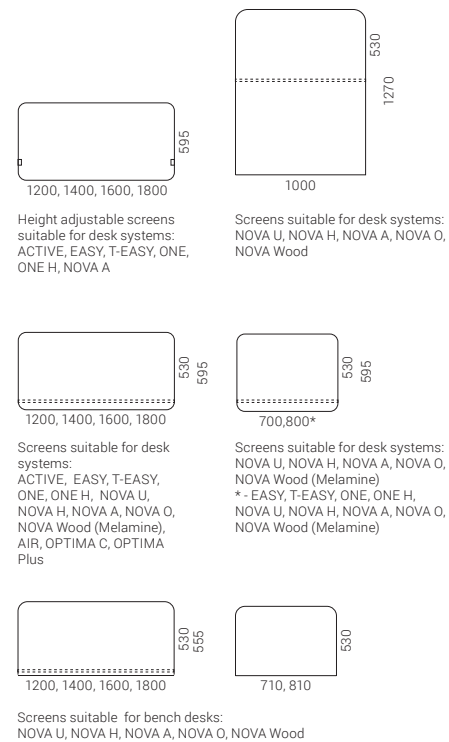



# JAZZ Silent Box

Design by Christina Strand and Niels Hvass

> 340  
LOUNGE  
& SOFT  
FURNITURE



200

A private and quiet space  
for meetings

JAZZ Silent Box is a quiet place of retreat in your office environment designed for meetings, brainstorming, individual work or relaxation. JAZZ Silent Box is made of special sound-absorbing material which delivers class D sound absorption.

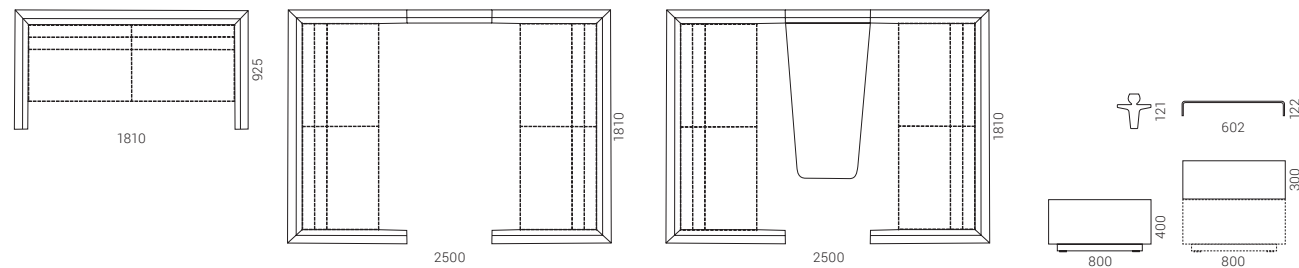

JAZZ Silent Box



Silent Box option with a table and a monitor holder will enable you to work on your computer conveniently and to display visual information on the screen during meetings. The furniture can also be equipped with a power outlet and a USB connection.

JAZZ Silent Box





202

203

Choose the acoustic walls of JAZZ Silent Box without the integrated soft furniture or table. Place your own customized combination of furniture within the acoustically pleasant and private environment of JAZZ Silent Box.



# MY SPACE

Create your space  
with MY SPACE

From private mini-rooms for concentration to collaboration areas for teamwork, this system provides a comfortable workplace, allows you to distance yourself from ambient noise, and opens up new "office-within-office" possibilities.

204



Proven acoustic  
characteristics

MY SPACE is a great choice to reduce the overall noise level of the office as the acoustic screens are filled with a special sound-absorbing foam and covered with upholstery of your choice.

205





# Make your office stand out

Different size and shape desktops make MY SPACE a flexible solution for almost any working environment while height-adjustment function helps create a convenient workplace for individual tasks.

Thanks to the modular construction, this acoustic furniture allows you to electrify up to 6 workspaces with a single power socket. MY SPACE is available with a 3 socket power unit that can be used for standard power supply, USB, or LAN connection in different configurations.

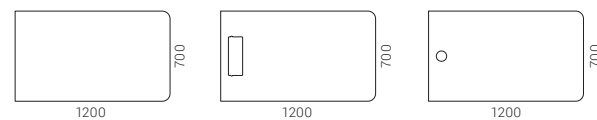
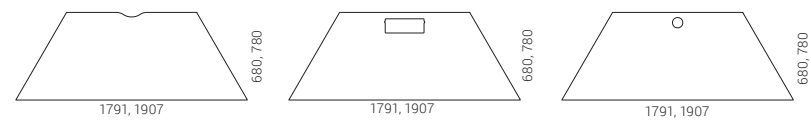
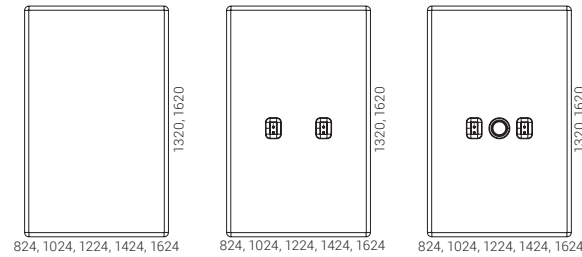

You can choose different interior and exterior colors for MY SPACE screens. Use your desired color combinations to create individual spaces or group workspaces.

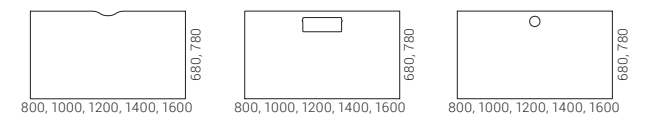





208

209



ACOUSTIC  
FURNITURE

# ARCIPELAGO Wood

Design by Baldanzi & Novelli designers

> 334  
LOUNGE  
& SOFT  
FURNITURE

## Escape busy office environment

ARCIPELAGO Wood lounge seating is ideal for creating an enclosed "room within a room" in open-plan offices. It serves as a meeting and work space where you can isolate yourself from ambient noise. This lounge seating is ideal for multiple uses: brief tasks or longer work sessions, meetings, teamwork or relaxation.

210



ARCIPELAGO Wood

## Design

ARCIPELAGO Wood has been designed by the Italian design studio Baldanzi & Novelli Designers. Aesthetic design, smooth shapes and natural elements bring a sense of warmth to the office.

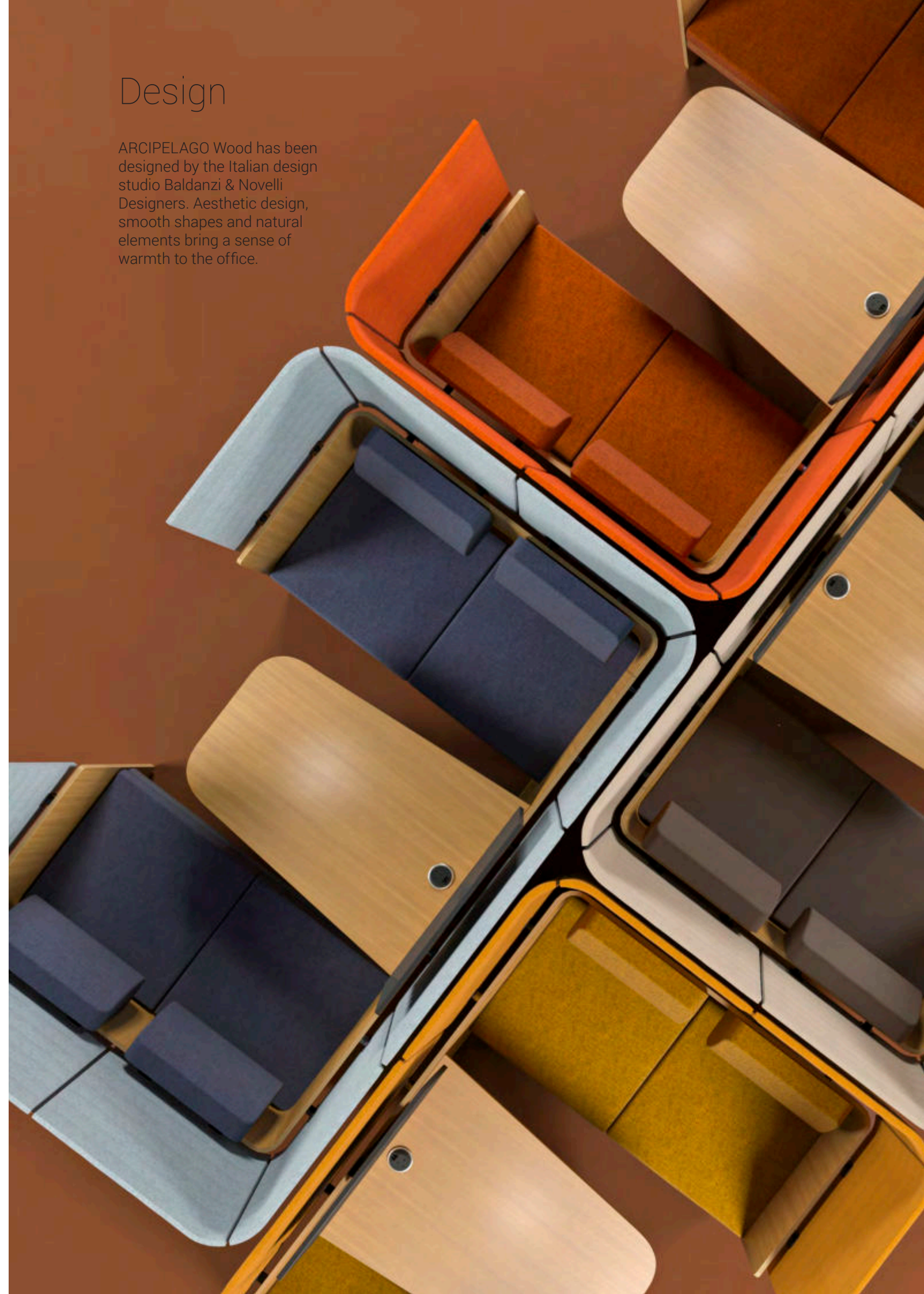





## Functionality

The seating unit can accommodate a monitor screen for convenient presentation of information during business meetings. The table is equipped with a power socket with integrated USB type A and C connectors for any work devices to make sure you never run out of energy.

213

## Comfort

Baldanzi & Novelli Designers who created ARCIPELAGO Wood compares this piece of furniture to an island which offers a natural retreat. ARCIPELAGO Wood high panels serve as barriers shielding employees from background noise while comfortable seating creates a laid-back and private environment.

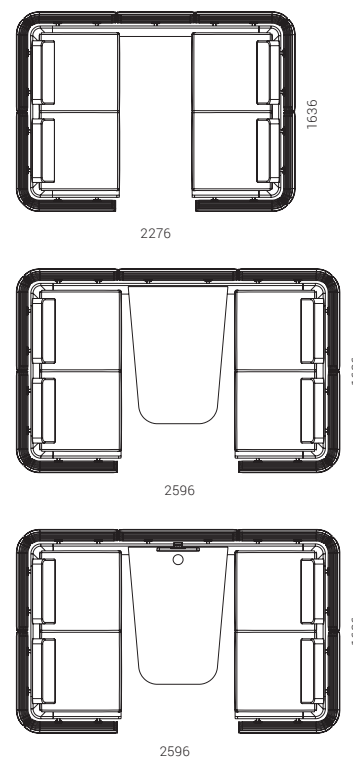



**ACOUSTIC  
FURNITURE**





# CHAIRS

## TASK CHAIRS

---



**SURF**  
> 216



**EVA**  
> 234



**DIVA**  
> 242



**WIND**  
> 222



**EVA.II**  
> 236



**AURA**  
> 244



**NORTH CAPE**  
> 230



**MOON**  
> 240

## HIGH SWIVEL CHAIRS

---



**WOBBY**  
> 246



**WIND**  
> 250

## EXECUTIVE CHAIRS

---



**NORTH CAPE**  
> 254



**AURA**  
> 260



**EVA.II**  
> 262

216

217



# VISITOR, CONFERENCE & DINING CHAIRS

# HIGH CHAIRS



**TWIST&SIT**  
> 272



**WIND**  
> 268



**EVA**  
> 298



**TWIST&SIT**  
> 302



**NORTH CAPE**  
> 276



**MOON**  
> 288



**AURA**  
> 300



**POLYTONE-L**  
> 304

218



**POLYTONE-C**  
> 282



**MOON Wood**  
> 292



**DIVA**  
> 301

219



**MOON**  
> 306



**POLYTONE-L**  
> 284



**WAIT**  
> 294



**MOON Wood**  
> 306



**POLYTONE-O**  
> 286



**GAMA**  
> 296



**WAIT**  
> 308



# SURF

An excellent design and undeniable sitting comfort

When it comes to style and comfort there's no need for compromise. This chair offers it all. Its main distinctive feature is an appealing backrest silhouette resembling a windsurfing sail. The backrest and lumbar support were created by the German designer Justus Kolberg.



220

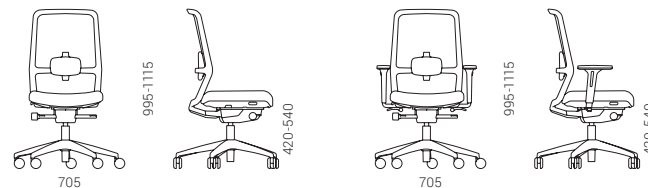

## Unique mesh

The mesh design combines functionality and aesthetics. It is a breathable, soft and light material with a special 3D structure. A wide mesh colour palette expands the possibilities of creating the perfect fit.





## Fine-tune your comfort level

SURF task chair provides great comfort and allows users to stay focused even after long hours of work.

222

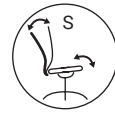

SYNCHRO  
MECHANISM

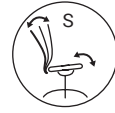

BACKREST TRAVEL  
LIMITATION



LOCKING  
POSITIONS



TENSION AD-  
JUSTMENT

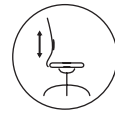

ADJUSTABLE LUMBAR  
SUPPORT

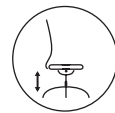

PNEUMATIC HEIGHT  
REGULATION

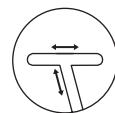

ADJUSTABLE  
ARMRESTS





TASK  
CHAIRS

TASK  
CHAIRS

RUNNER mesh  
RM6

STEP Melange  
L02

SURF

SURF





# WIND

Design by Baldanzi & Novelli designers

> 254

HIGH  
SWIVEL  
CHAIRS

> 268

VISITOR,  
CONFERENCE  
& DINING  
CHAIRS

“

*We felt the need to give this product a decisive character – an element defining its identity. Thus, we came up with an idea to create a back support made from a transparent and flexible material and to make it an anthropomorphic shape instead of a technical shape which would be pleasing to the eye and as clear as the wind blowing onto the sails of a ship or making leaves tremble.*

Baldanzi & Novelli Designers

226





WIND family of chairs offers a combination of ergonomic features, functionality and unique design. Task chairs, high swivel chairs and visitor chairs designed for dynamic and efficient work and collaborative use are ideally suited for modern office spaces characterized by a unifying and unique WIND design.

228



**WIND**



## Unique lumbar support

WIND has an instantly recognizable X-shape transparent lumbar support uniquely designed to enhance the chair's visual appeal and serve a very important function. Its height can be adjusted and it conforms to the user's lumbar shape due to the elastic properties of silicone to provide exceptional comfort.

229

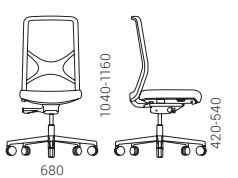
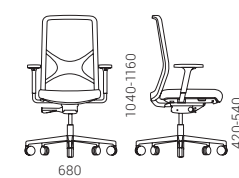
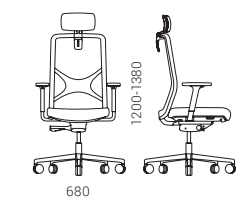
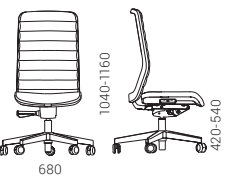
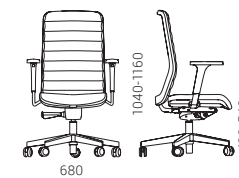

**WIND**



3 types of backrests

The backrest with a flexible mesh easily adapts to the natural shape of the user's spine. The aesthetic breathable mesh material ensures all-day comfort, no matter what seating position you use.



Micro-mesh

The mesh features a unique 3D structure which gives this chair a dynamic and distinctive look. This eye-catching and breathable fabric allows free circulation of air and helps prevent overheating. The soft and lightweight mesh adapts to the user's lumbar shape in order to keep the user comfortable throughout the day.



Runner mesh

The upholstered backrest is shaped with the principles of ergonomic seating in mind to ensure maximum workplace comfort. Its polyurethane insert with uniquely designed horizontal seams on both sides gives a totally different character to the chair. The backrest comes in a variety of upholstery options.



Fabric / leather look

Choose a backrest with a unique knitted mesh created by an Italian design studio Baldanzi & Novelli designers. The mesh design pattern follows the X shape to further enhance the lumbar support that creates the WIND chair's identity. The knitted mesh is made using cutting-edge technology which allows us to manufacture chairs with seamless backrest corners so no scrap material is left behind.



Knitted-mesh

Simple and intuitive adjustments

WIND encourages an ergonomically correct sitting position and provides the functionality you need. Thanks to its simple and intuitive adjustment, the chair can be easily adapted to individual user needs and offers maximum comfort for long stints at the desk.



SYNCHRONOUS MECHANISM



WEIGHT-SENSITIVE MECHANISM



SLIDE SEAT



LOCKING POSITIONS

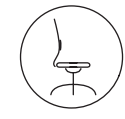

ADJUSTABLE LUMBAR SUPPORT



HEADREST

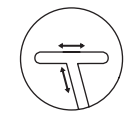

ADJUSTABLE ARMRESTS





TASK  
CHAIRS



WIND

WIND



# NORTH CAPE

Design by Baldanzi & Novelli designers

> 258  
EXECUTIVE  
CHAIRS

> 276  
VISITOR,  
CONFERENCE  
& DINING  
CHAIRS

Stylish, modern  
and adaptable

NORTH CAPE design is a combination of simple but at the same time strict lines and soft curves. Rectangular armrests made of polyurethane fit the backrest harmoniously. Unique, laconic curve of the backrest fluently going down to the line of the seating part, creates a subtle silhouette of the chair, which has already become the identity of this chair.

234

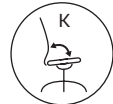

KNEE TILT  
MECHANISM



TENSION  
ADJUSTMENT



LOCKING  
POSITIONS



“

*When two different cultures with the same goal meet, a wonderful result is achieved. The aim of the project was to create a chair, having an exceptional identity, which would combine and reveal Italian and Lithuanian styles.*

Baldanzi & Novelli designers

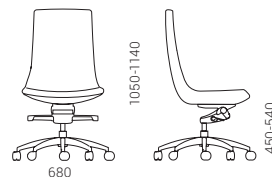
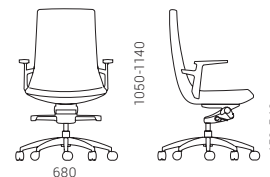
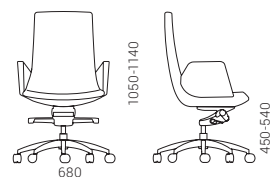











## Graceful style work chair

The chair's name EVA is a female name derived from the Hebrew name, meaning "life", may also have the meaning "lively". This is exactly what this task chair is, whose graceful shape is emphasized by the integrity of the backrest and seat.

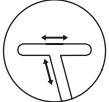

The EVA task chair has a tilting mechanism, it means that the backrest and the seat are connected, and when the backrest is reclined, the whole chair tilts. For the convenience of the user, the backrest can be locked in four different positions.

-  TILT MECHANISM
-  TENSION ADJUSTMENT
-  LOCKING POSITIONS
-  LUMBAR SUPPORT
-  ADJUSTABLE ARMRESTS

238



## Easy to feel comfortable

The back of the chair with a light, breathable polyester mesh adapts to the curves of the back and ensures comfortable support and constant air circulation. A stiffer plastic mesh for the back provides more support. The model with height-adjustable lumbar support - even better adapted to the shape of the user's back.

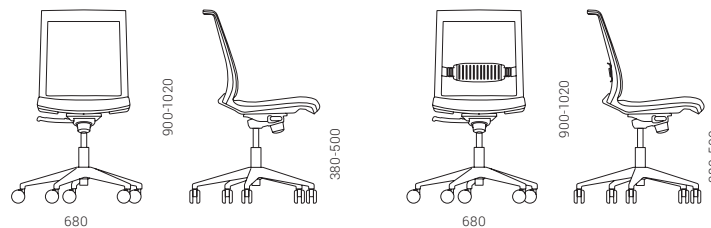

239





## Contemporary universal task chair

EVA.II's impetuous modern design, wide range of functionality and universal features make it a great choice for work environments both in the office and at home.

240



EVA.II



SYNCHRONOUS  
MECHANISM



TENSION  
ADJUSTMENT



LOCKING  
POSITIONS

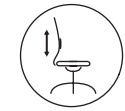

ADJUSTABLE  
LUMBAR SUPPORT

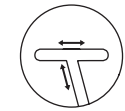

ADJUSTABLE  
ARMRESTS

## Comfortable backrest

The backrest with a light, porous polyester mesh moulds itself to the curvature of the user's back, ensuring comfort and constant airflow, while a firmer plastic mesh grants additional support. For a yet even better fit to the the shape of the user's back we recommend EVA.II with height-adjustable lumbar support.

241

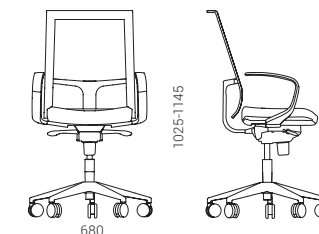
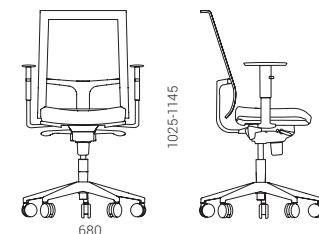

EVA.II







# MOON

> 288  
VISITOR,  
CONFERENCE  
& DINING  
CHAIRS

> 306  
HIGH  
CHAIRS

MOON chair integrate perfectly into the modern office environment, in which does not dominate, but by choosing brighter color solutions – it may become a stylish interior accent.



244

## For a shorter working day

The user will be able to quickly and easily adjust the chair for a comfortable seat, and start work immediately.



TILT  
MECHANISM



TENSION  
ADJUSTMENT

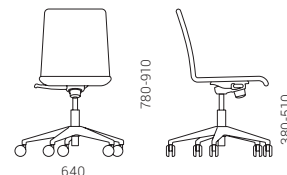









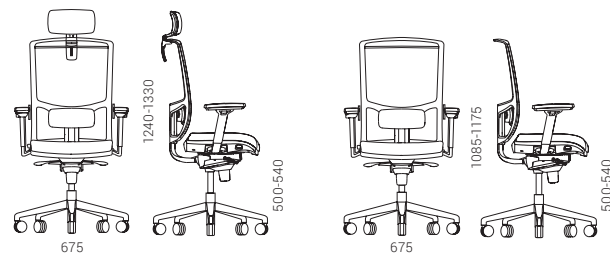

## Guaranteed ergonomics

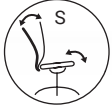
The main goal of this ergonomic chair is to become an indispensable partner for the user during the working day, ensuring dynamic sitting positions, exceptional comfort, and ease of use.



The chair is available with either black polyamide or polished aluminum 5-star base with castors. Thanks to its simple and intuitive design, DIVA can be easily adapted to individual user needs.



-  SYNCHRONOUS MECHANISM
-  TENSION ADJUSTMENT
-  BACKREST HEIGHT ADJUSTMENT
-  SLIDE SEAT
-  LOCKING POSITIONS
-  ADJUSTABLE LUMBAR SUPPORT
-  HEADREST
-  ADJUSTABLE ARMRESTS





# AURA

> 264  
EXECUTIVE  
CHAIRS

> 300  
VISITOR,  
CONFERENCE  
& DINING  
CHAIRS

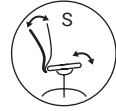

SYNCHRONOUS  
MECHANISM



TENSION  
ADJUSTMENT



LOCKING  
POSITIONS

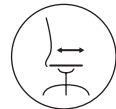

SLIDE SEAT

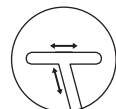

ADJUSTABLE  
ARMRESTS

248



AURA is designed to let you find a comfortable position for work as well as for relaxation. The seating part and the backrest are soft and give enough space to ensure comfort for a user.

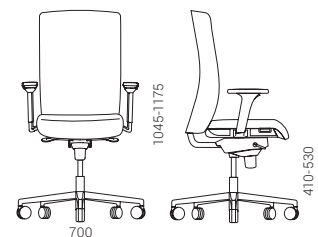



# WOBBY

## Your best office partner

The WOBBY pivoting stool is a great choice for those looking for healthier sitting alternatives. It is a perfect active sitting solution for dynamic work and cooperation areas. The upper part of the stool swings and moves together with its user, so it can also be used as a support when standing. This allows you to change the position of the body at the workplace throughout the day without distracting from important tasks. Due to its modern and sleek design, this balance chair will fit into any contemporary office space.

## Unique pivoting system

The distinctive feature of this chair is its unique pivoting system, hidden inside an elegant black plastic base. With the help of this system, the seat can be tilted up to 8 degrees in all directions and rotated 360 degree.

## Easily adjusted and safe

A pneumatic lift mechanism lets you fine-tune the perfect level for different work surface heights. Adjustable seat height range from 600 mm to 850 mm, so you can smoothly adjust from sit to stand position in seconds by using an elegant brown leather strap. Having a non-skid surface, the base of the stool will always remain stable, while the high-quality materials will ensure safe and long-lasting use.

250



251

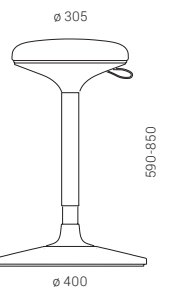



## Significant functionality

The WOBBY pivoting stool can be easily fit with to height-adjustable desks, as well as high, or conference tables. Due to its compact size, this chair is also perfect for different size SILENT ROOM acoustic rooms or small meeting rooms. The seat of the stool is made of polyurethane and can be upholstered in a wide selection of fabric, genuine leather, and leather look.

252

SYNERGY  
S68



253

ERA  
009

SYNERGY  
S68





# WIND

Design by Baldanzi & Novelli designers

> 226

TASK CHAIRS

> 268

VISITOR, CONFERENCE & DINING CHAIRS

## Dynamic and flexible work setting

The standards of ergonomic in modern office spaces are constantly changing, just as our understanding as to what work environment is best for the performance and well-being of office workers. One thing is clear: it is important to change one's body posture throughout the day and avoid staying in the same position for extended periods of time. WIND high task chair is great because it can be easily adapted to a variety of work settings, whether it is a sit-stand desk, a high desk or reception furniture.



ADJUSTABLE LUMBAR SUPPORT

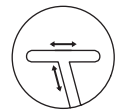

ADJUSTABLE ARMRESTS



PNEUMATIC HEIGHT REGULATION



FOOTRING HEIGHT ADJUSTMENT

254

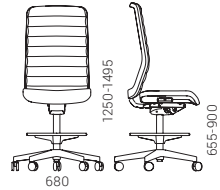
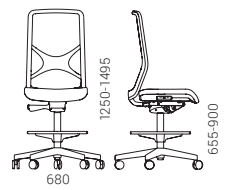
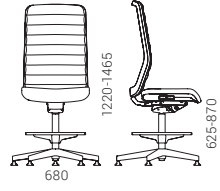
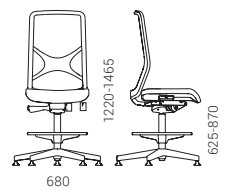



# HIGH SWIVEL CHAIRS

## Keeping you comfortable and safe

With their soft, comfortably shaped seat and ergonomically designed mesh backrest, WIND chairs are comfortable to sit on even for long periods of time. Ring-shaped adjustable-height leg rest allows you to adjust the chair to your height, maintain a correct seating position and avoid unpleasant back and neck pain. The castors will provide extra safety and stability as they will be locked in place while you sit.

256

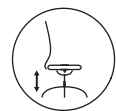

PNEUMATIC HEIGHT REGULATION

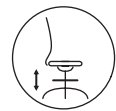

FOOTRING HEIGHT ADJUSTMENT

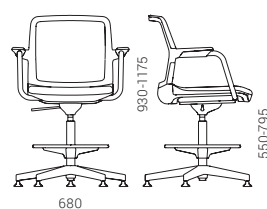
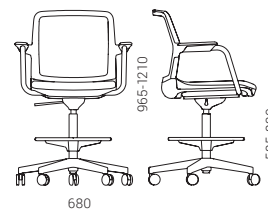

WIND

# HIGH SWIVEL CHAIRS



WIND



EXECUTIVE  
CHAIRS

# NORTH CAPE

Design by Baldanzi & Novelli designers

> 234  
TASK  
CHAIRS

> 276  
VISITOR,  
CONFERENCE  
& DINING  
CHAIRS

In harmony with modern  
elegance and comfort

Creating the manager's office using these chairs, you will  
ensure not only a stylish workplace but also comfort.



reddot winner 2021  
office design

258

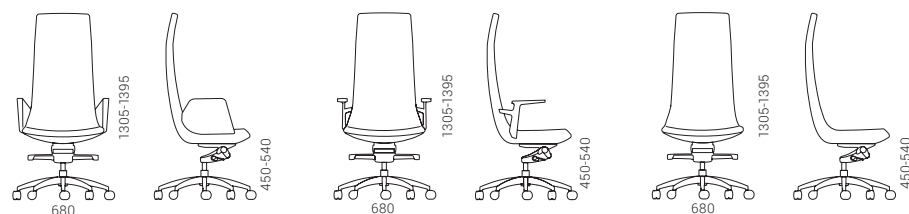

NORTH CAPE

EXECUTIVE  
CHAIRS



NORTH CAPE





KNEE-TILT  
MECHANISM



TENSION  
ADJUSTMENT



LOCKING  
POSITIONS

## Create different images

In order to accomplish desired style for the executive office, you can choose from 2 models: laconic, simple but elegant design or much more sophisticated silhouette with a bigger backrest, softer seating pad and unique pattern of horizontal stitching lines.

260

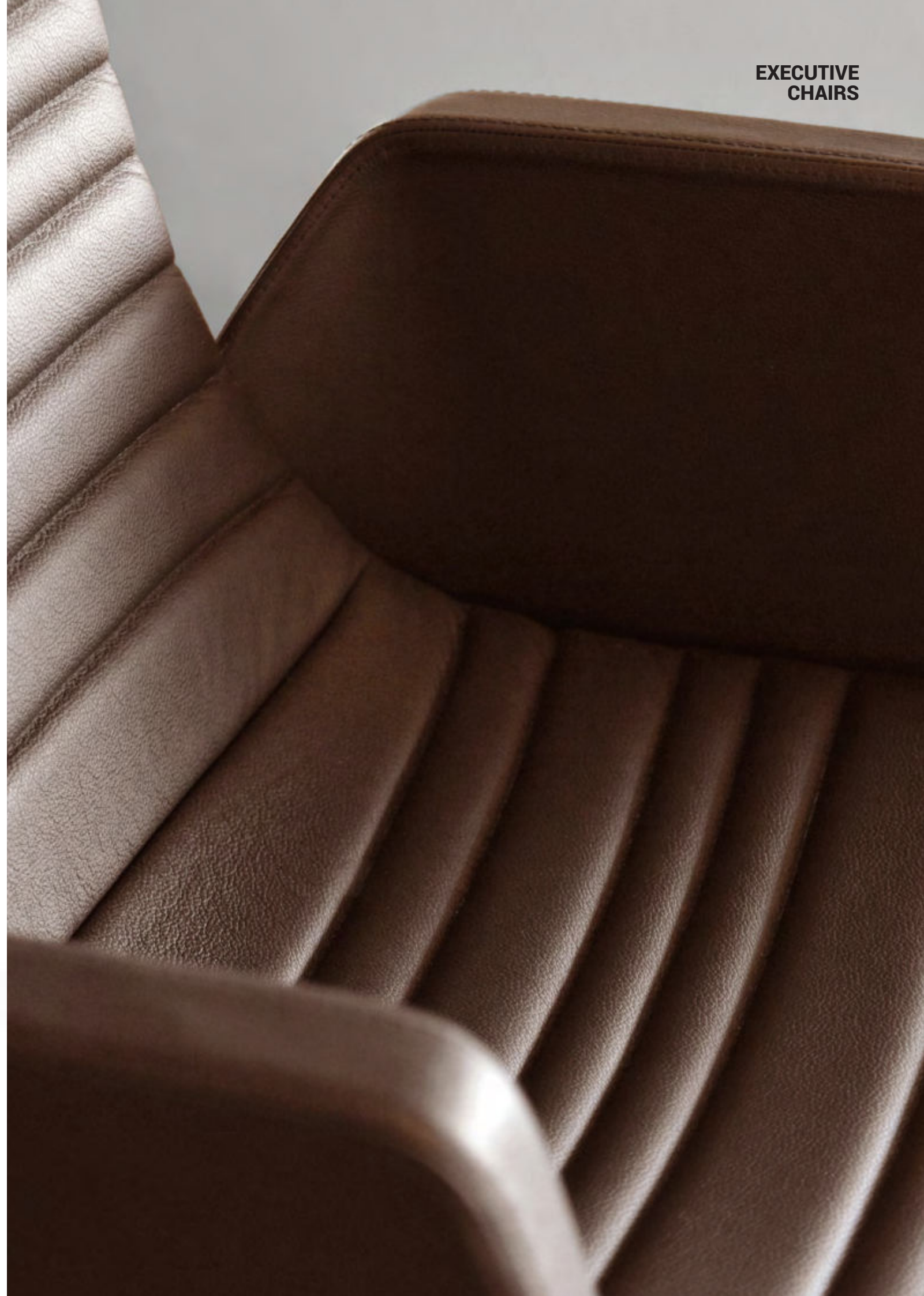
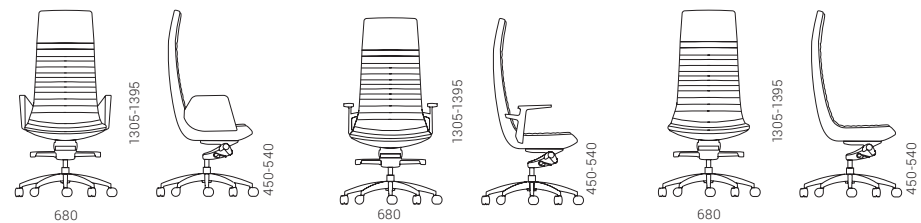



EXECUTIVE  
CHAIRS



NORTH CAPE

NORTH CAPE



# AURA

> 248  
TASK  
CHAIRS

> 300  
VISITOR,  
CONFERENCE  
& DINING  
CHAIRS

Good aura at work is essential just like air

Aura chair harmoniously combines timeless, universal design and comfort, which is ensured by ergonomic functions of the chair and spacious seating part.

264

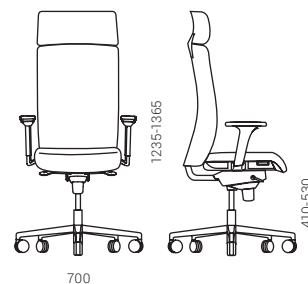

265

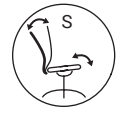

SYNCHRONOUS MECHANISM



TENSION ADJUSTMENT



SLIDE SEAT



LOCKING POSITIONS



HEADREST



ADJUSTABLE ARMRESTS



## Universal task chair for executives

EVA.II's impetuous modern design, wide range of functionality and universal features make it a great choice for work environments both in the office and at home. This chair can easily be adjusted to suit various different needs.

266



## Comfortable back and head rests

The backrest with a light, porous polyester mesh moulds itself to the curvature of the user's back, ensuring comfort and constant airflow, while a firmer plastic mesh grants additional support. The executive chair variant also has a soft polyurethane headrest, which helps reduce neck muscle tension during long work hours.

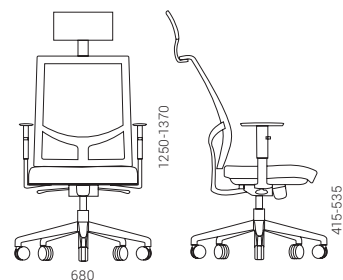

## Different variations and images

Design EVA.II according to your own preference by choosing between the various frame, mesh and seat colour, as well as base options.



SYNCHRONOUS  
MECHANISM



TENSION  
ADJUSTMENT



LOCKING  
POSITIONS

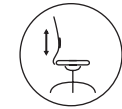

ADJUSTABLE  
LUMBAR SUPPORT



HEADREST

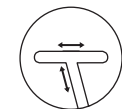

ADJUSTABLE  
ARMRESTS

267





## Continuous yet distinctive design

One of the main features is its uniform design including the structure of the back and armrests as well as the upholstered seat.

Blends in any office  
environment



4-legs

4-star

Cantilever

5-star



STACKABLE

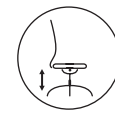

PNEUMATIC HEIGHT  
REGULATION

WIND visitor chairs are extremely versatile and perfectly suited for meeting, conference or reception areas. These chairs come in four different base options which can be easily adapted to a variety of office settings.

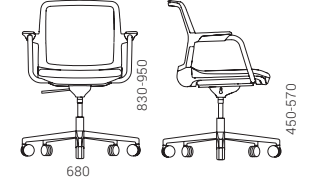
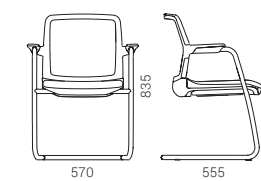
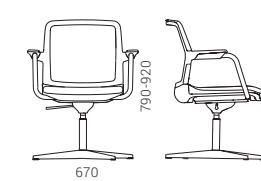
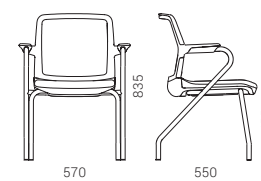



VISITOR,  
CONFERENCE  
& DINING  
CHAIRS

VISITOR,  
CONFERENCE  
& DINING  
CHAIRS



WIND

WIND



# TWIST&SIT

Design by Christina Strand and Niels Hvass

“

*Elegant and divided back enlarges the comfort of the chairs and at the same time the chair has a strong iconic expression.*

Christina Strand and Niels Hvass

> 302

HIGH  
CHAIRS

> 314

> 316

> 320

> 324

LOUNGE  
& SOFT  
FURNITURE

Distinctive character and freedom of expression for your style

272



273



STACKABLE

These chairs can be adapted based on the desired interior style as you can choose between industrial style metal legs and Scandinavian style wooden legs. The curved shell and ergonomic seating position makes collaboration process even more comfortable.

The TWIST&SIT chair can be used on its own or in large groups that look great in any space either it's a reception, conference hall or a meeting room.

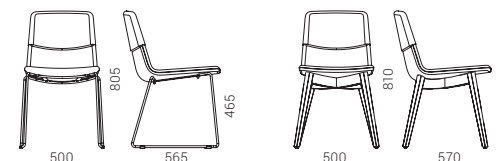



VISITOR,  
CONFERENCE  
& DINING  
CHAIRS

VISITOR,  
CONFERENCE  
& DINING  
CHAIRS

SYNERGY  
S62

SYNERGY  
S61

VELITO  
GT9





VISITOR,  
CONFERENCE  
& DINING  
CHAIRS

# NORTH CAPE

Design by Baldanzi & Novelli designers

> 234  
TASK  
CHAIRS

> 258  
EXECUTIVE  
CHAIRS

NORTH CAPE chairs are refined and stylish, thus can perfectly represent company in meeting and guest areas.

VISITOR,  
CONFERENCE  
& DINING  
CHAIRS

## 2 sizes for different needs

Chairs with lower backrests do not have armrests and are perfect for sitting comfortably in waiting or smaller meetings areas. Conference chairs with the same seating part proportions and armrests like those of task chairs are suitable for more spacious meetings rooms, where longer, more important and likely representative meetings take place.



## A choice from 3 bases



276



277

There are three options for NORTH CAPE visitor chair base, which suit different needs and office areas. Swivel, 4-leg base in polished aluminium provides elegance and sophistication. Chairs with cantilever base or 4-leg base are convenient for smaller, cosier meeting areas.

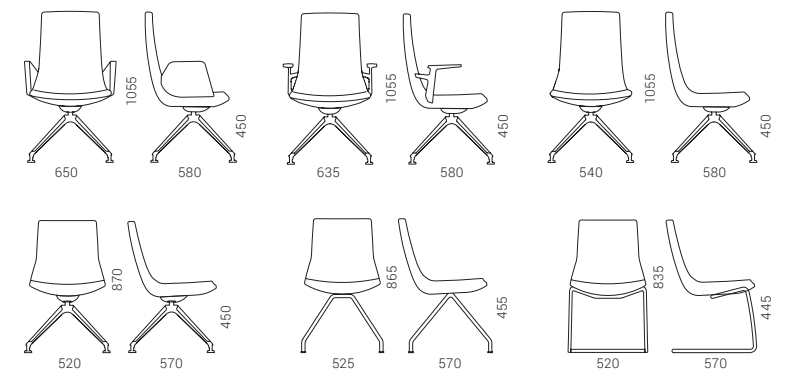



VISITOR,  
CONFERENCE  
& DINING  
CHAIRS

VISITOR,  
CONFERENCE  
& DINING  
CHAIRS



NORTH CAPE

NORTH CAPE



VISITOR,  
CONFERENCE  
& DINING  
CHAIRS

# POLYTONE

> 282

> 284

> 286

VISITOR,  
CONFERENCE &  
DINING CHAIRS

> 304

HIGH  
CHAIRS

The modern  
rhythm of  
work

A modern work environment – is more than just a comfortable and ergonomic personal workstation. It encompasses a wide range of different activities which revolve around a practical, functional and stylish chair. POLYTONE collection consists of three types of visitor, conference and dining chairs made of plastic: POLYTONE-C, POLYTONE-L and POLYTONE-O.

Practical  
and durable  
material

POLYTONE chairs are made of premium-grade polypropylene plastic. Plastic is one of the most versatile materials which is appreciated not only for its affordable price but also for easy maintenance and durability.

280



VISITOR,  
CONFERENCE  
& DINING  
CHAIRS



POLYTONE



VISITOR,  
CONFERENCE  
& DINING  
CHAIRS

# POLYTONE-C

Design by Sandonà and Sabrina Bettini

> 284

> 286

VISITOR,  
CONFERENCE &  
DINING CHAIRS

> 304

HIGH  
CHAIRS

Timeless modern  
classics

These chairs embody modern classics with timeless elegance. They add a lively and warm feel both to formal meeting spaces or informal relaxation areas.

Three types of bases  
for different needs

282

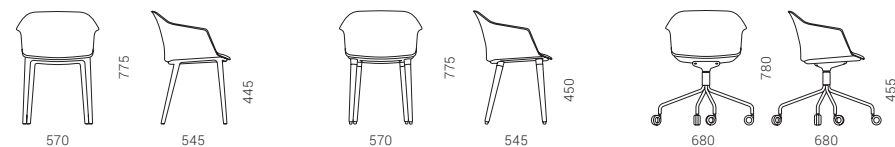

POLYTONE-C



283

POLYTONE-C



**VISITOR,  
CONFERENCE  
& DINING  
CHAIRS**

# POLYTONE-L

Design by Scagnellato and Ferrarese Design

> 282

> 286

VISITOR,  
CONFERENCE &  
DINING CHAIRS

> 304

HIGH  
CHAIRS



**VISITOR,  
CONFERENCE  
& DINING  
CHAIRS**



284

Subtle minimalist design

Visitor, conference and dining chairs boast a subtle minimalist design, and a wide range of bases and height options allows for the simple arrangement of large interior spaces.



STACKABLE



WRITING TABLET

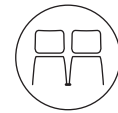

CONNECTORS

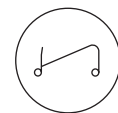

TROLLEY

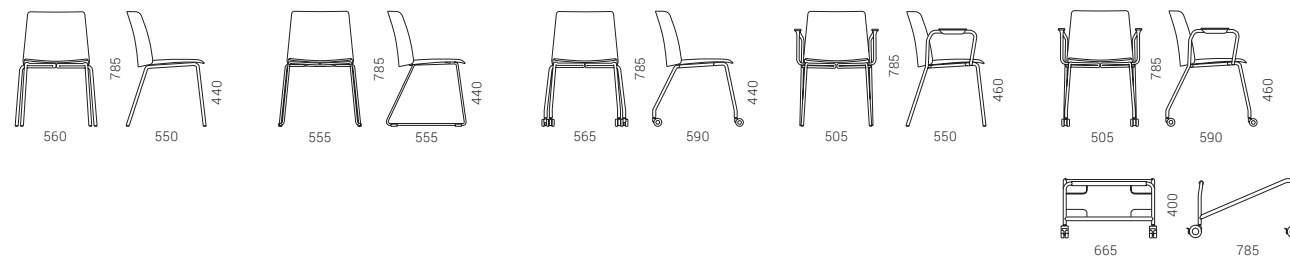

POLYTONE-L

POLYTONE-L

285



VISITOR,  
CONFERENCE  
& DINING  
CHAIRS

# POLYTONE-0

Design by Orlandini Design

> 282

> 284

VISITOR,  
CONFERENCE &  
DINING CHAIRS

> 304

HIGH  
CHAIRS

A stylish office for  
any weather

These 100% plastic compact chairs featuring thin lines and ergonomic shape will look stylish both in indoor and outdoor spaces. It is a very versatile choice in terms of both use and maintenance.



reddot award 2017  
winner



286

## Recycled plastic

We continue to contribute to the creation of sustainable projects offering the chair versions in black and light grey colours made from 100% recycled plastic – a mixture of reused materials, such as industrial and consumer waste.



STACKABLE

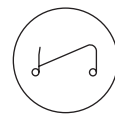

TROLLEY

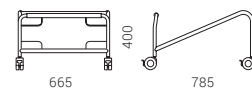
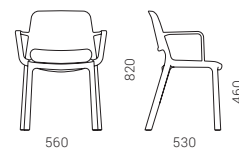
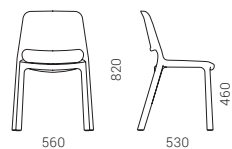

POLYTONE-0

POLYTONE-0

VISITOR,  
CONFERENCE  
& DINING  
CHAIRS



287



Conference chairs  
with a light, minimalist  
silhouette

Participants in every  
conference

Because of their simple construction, MOON visitor chairs are very convenient for conference and training rooms. It is easy to arrange them in orderly rows by using connectors.

288



289



Being compact and easily stackable (up to 5 chairs), they save your storage space and are convenient for transportation. Also, for user's convenience, it is possible to add a rotatable writing tablet, which can be fixed to a chair with armrests.

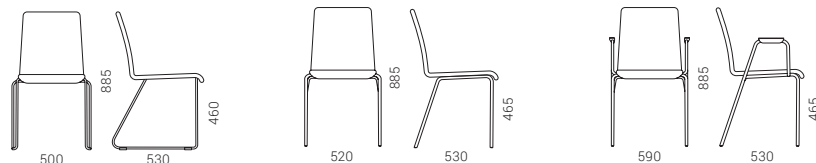



**VISITOR,  
CONFERENCE  
& DINING  
CHAIRS**

## Bases of two types

There are two different steel bases available for MOON conference chairs: traditional 4-leg or elegant sled frame which is made of very thin and elegant lines. The sled base has plastic glides which help to move the chair very easily without any damage to the floor.



STACKABLE



WRITING TABLE



CONNECTORS

290



MOON



MOON



VISITOR,  
CONFERENCE  
& DINING  
CHAIRS

# MOON

## Wood

> 306  
HIGH  
CHAIRS

VISITOR,  
CONFERENCE  
& DINING  
CHAIRS



STACKABLE



WRITING TABLE

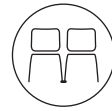

CONNECTORS

292 Work breaks  
without any  
worries

Monobloc unit of the backrest and the seating part is made of plywood. Because of high quality materials, MOON Wood visitor chairs are perfect for office areas in which employees take some rest, eat or simply have a coffee break. Don't worry if your chairs get dirty, as the surface can be cleaned easily.

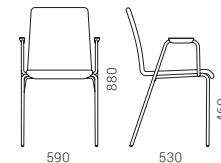
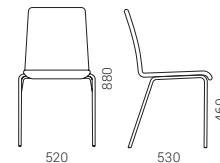
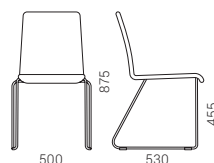



Playfulness in  
the office

They are modern, practical, and light, but at the same time durable, so they are perfect for conference and training halls, office spaces where visitors are received or where you can eat and relax.



294



Choose from a range of different colors of plastic and tapestries and you will definitely fulfill any interior.



295



STACKABLE



WRITING TABLE

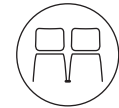

CONNECTORS

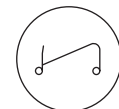

TROLLEY

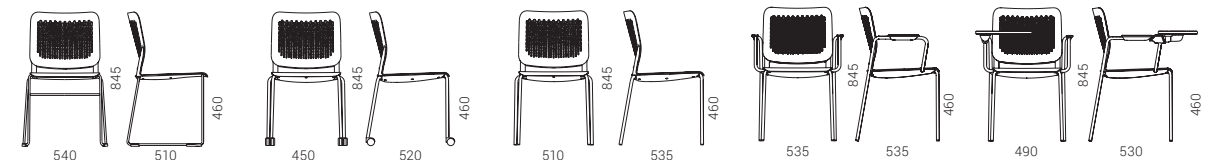
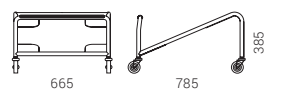



VISITOR,  
CONFERENCE  
& DINING  
CHAIRS

# GAMA

Any place, any time

It was created for those who appreciate comfort, easy-to-adapt style, and functionality.



296

Different features  
for different needs

There are three different steel bases available for GAMA chair system: a traditional 4-leg base, a cantilever frame base, and a 4-leg base with castors for an easier movement in spaces. All bases can be either chromed or powder-coated (metallic or black).

The backrest of the chair can be upholstered with either fabric or mesh.

Being stackable, (up to 6 chairs) these chairs are easy to transport and can optimize the room space.



STACKABLE

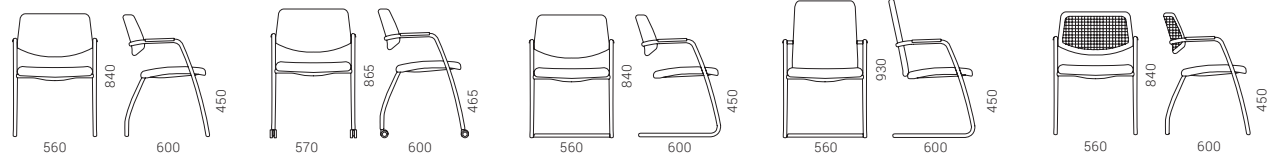

GAMA

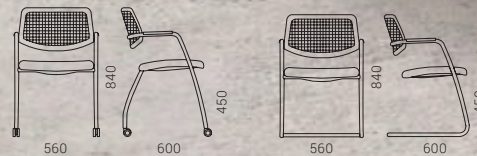

GAMA



Light and graceful  
silhouette visitor chair

For convenient  
meetings

298

The back of the visitor's chair can be combined with a lightweight and breathable polyester mesh that provides comfortable support and constant air circulation, or with a stiffer plastic mesh that provides greater support for the back.

Chrome-plated flexible steel frame legs ensure comfortable seating during long and intense meetings. During the moment of relaxation, you can easily swing in the chair.



## Compactness

You can easily stack EVA visitor chairs on top of each other (up to 3 pcs.).



STACKABLE

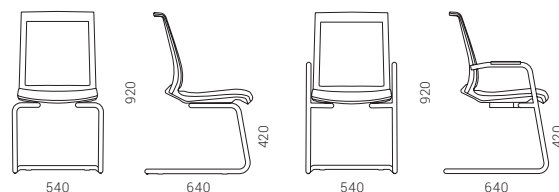



VISITOR,  
CONFERENCE  
& DINING  
CHAIRS

# AURA

> 248

TASK  
CHAIRS

> 265

EXECUTIVE  
CHAIRS



STACKABLE

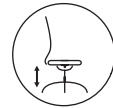

PNEUMATIC HEIGHT  
REGULATION

300

## Easily adaptable design

Wide variety of fabric and leather colours allows you to choose a character for your chair - from modest, easily adaptable to different office interiors, to exclusive, attracting attention.

## 4 base types

Depending on your circumstances, you can choose between four different bases. All of them are chromed, making it easy to match them to various fabric types and colours.

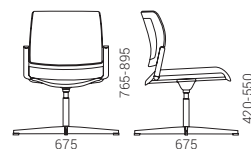
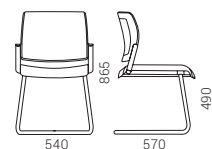
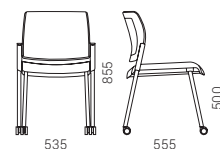
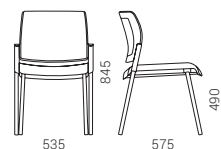

AURA

# DIVA

> 246

TASK  
CHAIRS

VISITOR,  
CONFERENCE  
& DINING  
CHAIRS



Thin line,  
delicate and  
modern design

The chair is available with either black polyamide or polished aluminum base with castors. Thanks to its simple and intuitive design, DIVA can be easily adapted to individual user needs.



TILT  
MECHANISM



TENSION  
ADJUSTMENT

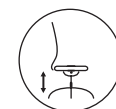

PNEUMATIC HEIGHT  
REGULATION



301

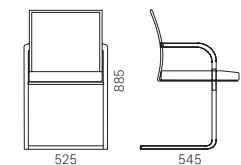
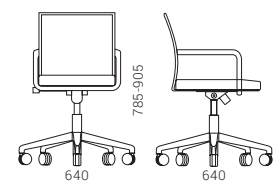

DIVA



# TWIST&SIT

Design by Christina Strand and Niels Hvass

> 272  
VISITOR,  
CONFERENCE &  
DINING CHAIRS

> 314

> 316

> 320

> 324

LOUNGE  
& SOFT  
FURNITURE

302



These Scandinavian design chairs are a perfect fit for high tables in the lounge, cafeteria, or collaboration areas. With their appealing look, they will get employees together for lunch, coffee break, or for an informal meeting. The ergonomically shaped curves in both the seat and backrest give users extra comfort. You can select different colour combinations for the upholstered part of the chair and choose either metal or wooden legs. Contrasting colours will bring a sense of exclusivity to your TWIST&SIT furniture.

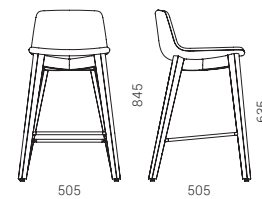
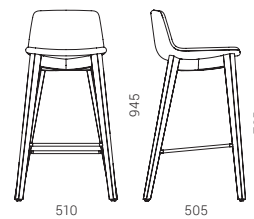
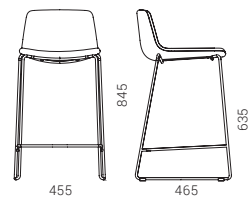
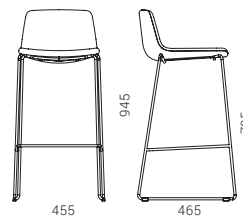



HIGH  
CHAIRS

# POLYTONE-L

Design by Scagnellato and Ferrarese Design

> 282

> 284

> 286

VISITOR,  
CONFERENCE &  
DINING CHAIRS

Stylish one-colour  
combinations

The plastic seat comes in the same colour as the metal base, creating a uniform look. The five colour options including pastel shades, which are currently very popular, will help you create laconic one-colour combinations.

304



Fixed cushion for  
added comfort

You can opt for a chair with a fixed cushion to ensure added comfort when sitting for extended periods of time. Our wide range of fabrics provides endless opportunities to mix and match the colour of the cushion with the colour of the plastic part of the chair.



STACKABLE

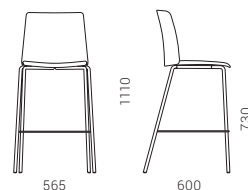

POLYTONE-L

HIGH  
CHAIRS



305

POLYTONE-L



HIGH CHAIRS

# MOON

> 244  
TASK  
CHAIRS

> 288  
VISITOR,  
CONFERENCE &  
DINING CHAIRS



MOON high chairs are a versatile option as they can be used for multiple purposes: in relaxation or dining areas as well as for short meetings.

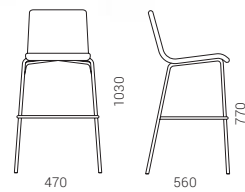

HIGH CHAIRS



306

# MOON Wood

> 292  
VISITOR,  
CONFERENCE &  
DINING CHAIRS

If you are inspired by nature, you can choose plywood chairs covered with beech or oak veneer. If you prefer minimalist style, black stained beech veneer or white laminate will be an ideal choice for you.



STACKABLE

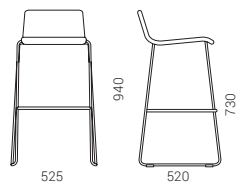



## Playful yet practical

Wait chairs are modern, practical and light, but at the same time durable. The delicately perforated back ensures air circulation. The chairs playfully combine two materials - plastic and fabric. You can choose from two models: a model where both the backrest and the seat are made of plastic and one that combines a perforated plastic backrest and a seat covered with a tapestry or leather look for a more comfortable seating.

308



309

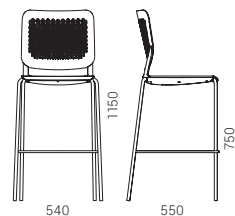



# LOUNGE & SOFT FURNITURE

## SOFAS

---

310



TWIST&SIT Soft  
> 316



ARCIPELAGO  
> 334



CUMULUS  
> 345

## LOUNGE CHAIRS

---



SOFT ROCK  
> 328



TWIST&SIT Soft  
> 314



TWIST&SIT  
> 320



ARCIPELAGO  
> 334



VEGAS  
> 344



CUMULUS  
> 345

311



# ARMCHAIRS



**TWIST&SIT**  
> 324



**MEG**  
> 350



**TULA**  
> 346



**LUNA**  
> 351



**DANAE**  
> 348



**NORTH CAPE**  
> 276

312

# MODULAR SYSTEMS



**SOFT ROCK**  
> 328



**ARCIPELAGO**  
> 334



**JAZZ Chill Out**  
> 340



**CUMULUS**  
> 345

# POUFS



**GIRO**  
> 342



**JAZZ Chill Out**  
> 340



**ARCIPELAGO**  
> 334

313



# TWIST&SIT

## Soft

Design by Christina Strand and Niels Hvass

- > 272  
VISITOR,  
CONFERENCE &  
DINING CHAIRS
- > 302  
HIGH  
CHAIRS
- > 316
- > 320
- > 324  
LOUNGE  
& SOFT  
FURNITURE

Exceptional  
design  
rhythms

314



315



### An invitation to pause

TWIST&SIT Soft lounge furniture with its expressive design is an invitation to pause and to take a break from the hectic pace of the day.

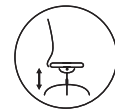

PNEUMATIC HEIGHT  
REGULATION

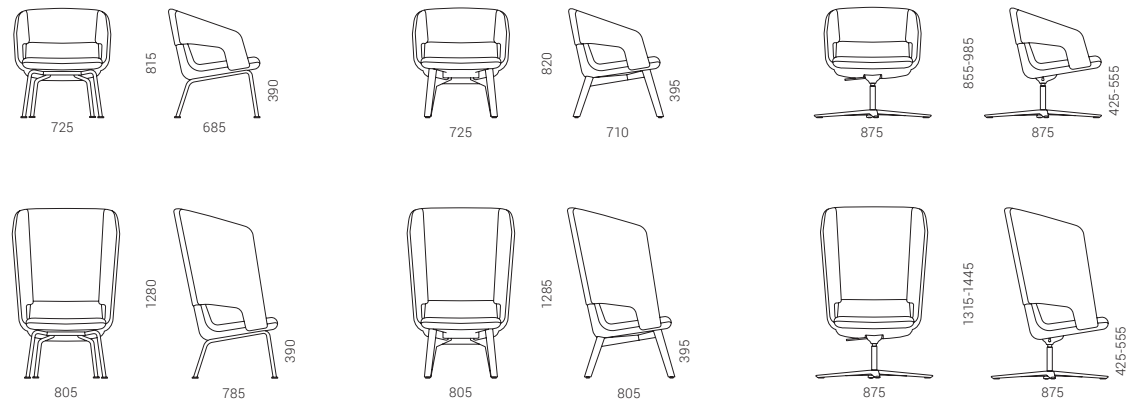

Well-rounded shapes and a distinctive connection between the lower and upper parts of the backrest create an instantly recognisable look.



# TWIST&SIT

## Soft

Design by Christina Strand and Niels Hvass

- > 272  
VISITOR,  
CONFERENCE &  
DINING CHAIRS
- > 302  
HIGH  
CHAIRS
- > 314
- > 320
- > 324  
LOUNGE  
& SOFT  
FURNITURE



316

An ultimate sense  
of comfort

TWIST&SIT Soft seaters ensure a comfortable sitting experience thanks to the increased thickness of the polyurethane padding. The recessed lower part of the backrest subtly conforms to the natural contours of the spine, making the user feel comfortable.

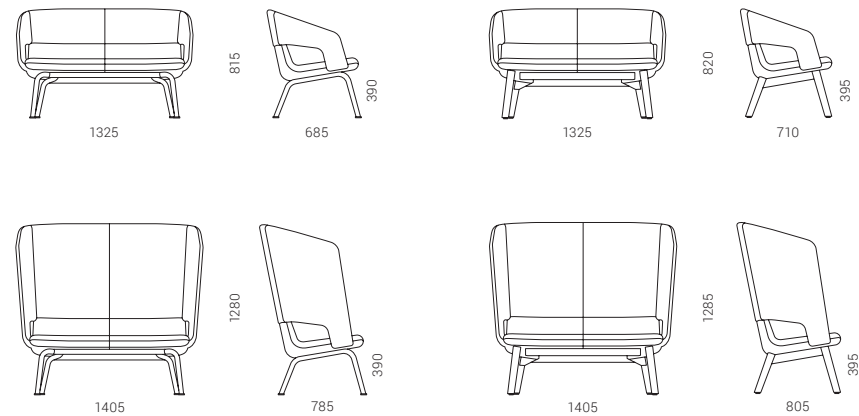

TWIST&SIT Soft

Meets  
the diverse  
needs of  
employees

Low-back armchairs and sofas are ideal for office reception areas or open-plan relaxation spaces, lounge zones or cafés. High-back seaters are a convenient solution for employees who need a private space for themselves where they can escape from the noisy office environment and relax or focus on individual tasks.



317

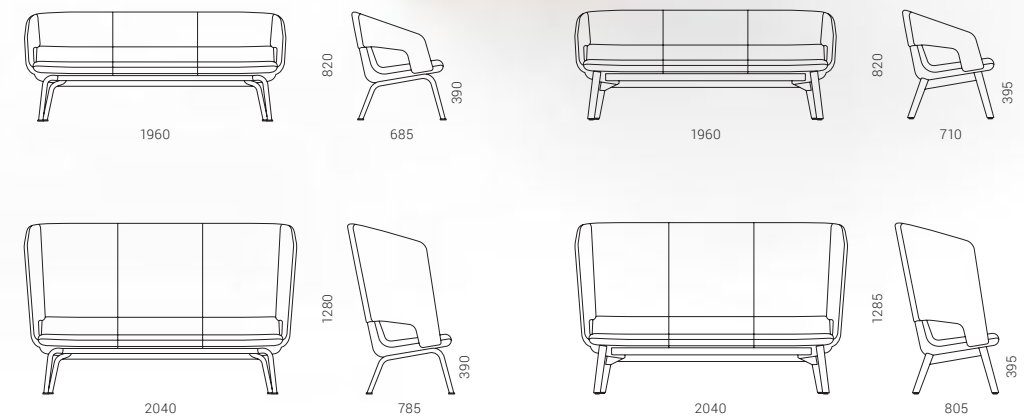

TWIST&SIT Soft



SYNERGY  
S85

SYNERGY  
S53

SYNERGY  
S27

SYNERGY  
S55

SYNERGY  
S08

SYNERGY  
S45



# TWIST&SIT

Design by Christina Strand and Niels Hvass

> 272

VISITOR,  
CONFERENCE &  
DINING CHAIRS

> 302

HIGH  
CHAIRS

> 314

> 316

> 324

LOUNGE  
& SOFT  
FURNITURE

320



reddot award 2019  
winner

An exclusive design of TWIST&SIT chair will be a spotlight of any office. It has a well-rounded high backrest shelter which isolates the users from surrounding noise, giving them a sense of comfort, protection, and minimizing distractions. The seat of the TWIST&SIT is wider than a typical size seat, thus it allows you to relax and enjoy an ultimate sense of comfort. The chair will add a special touch to both formal and informal meeting spaces or relaxation areas.





**LOUNGE  
& SOFT  
FURNITURE**

Distinctive  
character and  
freedom of  
expression for  
your style

You can select different colour combinations for the upholstered part of the chair. Contrasting colours will bring a sense of exclusivity to your TWIST&SIT furniture. It also comes in a variety of different base options so there is no need to compromise on style. When choosing the right one, consider your functional needs as well as the fabric or design to accommodate your preferences.

322

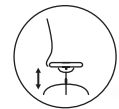

PNEUMATIC HEIGHT  
REGULATION

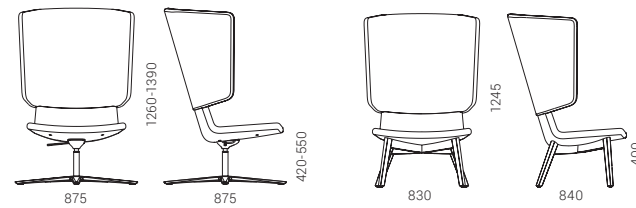

**TWIST&SIT**





# TWIST&SIT

Design by Christina Strand and Niels Hvass

> 272  
VISITOR,  
CONFERENCE &  
DINING CHAIRS

> 302  
HIGH  
CHAIRS

> 314

> 316

> 320

LOUNGE  
& SOFT  
FURNITURE



324

TWIST&SIT furniture stands out for its minimalist and clean refined lines as well as strong visual identity. The rounded edges and smooth transitions between the backrest and the armrests offer a comfortable seating position even if the work meeting lasts longer than expected.

TWIST&SIT chairs with metal bases have a more modern look, whereas the wooden ones give the office a more homely feel and at the same time add more elegance to the room. Both base options are available in dark and light colours to further add to the beauty of contrast.

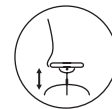

PNEUMATIC HEIGHT  
REGULATION

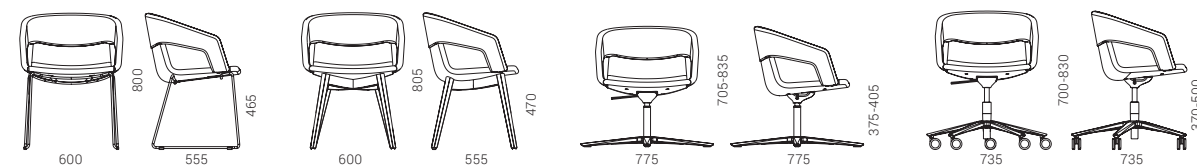

With its visually striking Scandinavian design, this soft seating family is perfect for modern offices that exude a chic vibe and looks just as nicely in traditional office spaces. TWIST&SIT collection offers a perfect combination of expressiveness, improvisational freedom and a variety of styles.



LOUNGE  
& SOFT  
FURNITURE





# SOFT ROCK

Design by Christina Strand and Niels Hvass

Inspired by the new generation

Being open to new things, a sense of freedom, and the ability to adapt quickly to changing situations were the source of inspiration behind SOFT ROCK lounge seating collection.



328

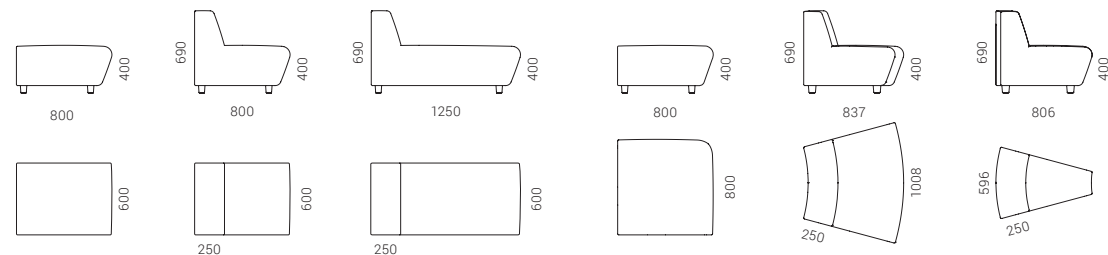
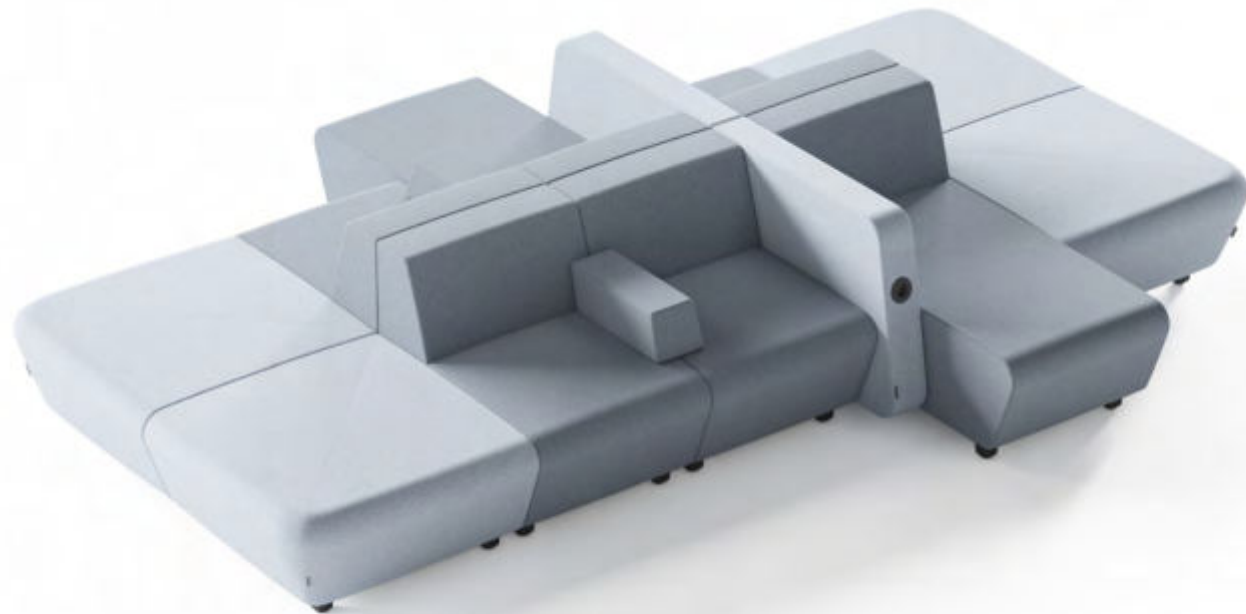

SOFT ROCK

Flexible modular system

Unleash your creativity and set up desired combinations by selecting from six main lounge seaters available in different sizes and forms, which can be easily combined or rearranged to make efficient use of the space. Depending on your actual needs, use additional accessories – armrests and screens to make the most of your lounge seater composition.

329





## Privacy and safety

It is a perfect tool allowing you to create a more private area for individual work that requires concentration within an open space. Also, thanks to the screens, you can create a safe atmosphere by ensuring desired distances between people without totally isolating them.

330

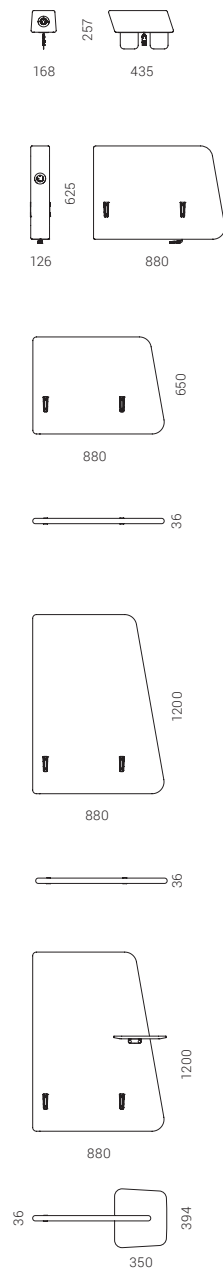

Always  
"connected"



In order to meet your need for constant connectivity, the armrests of the SOFT ROCK furniture have in-built power sockets or fast charging USB (Type A+C) ports.

RNN  
D17





SYNERGY  
S62

SYNERGY  
S63

“

*SOFT ROCK reflects a youthful and relaxed feel and offers numerous possibilities to set up and combine different spaces.*

Christina Strand and Niels Hvass



Design by Baldanzi & Novelli designers

## Release your creativity with ARCIPELAGO!

Arcipelago is a modular lounge seating system offering endless configuration possibilities. Choose your favourite configuration from our wide range of standard options or build your custom configurations by mixing and matching modular components. ARCIPELAGO modular configurable system is easy to assemble, disassemble, or reassemble.



334



ARCIPELAGO



## Playful colours

335

Choose from our wide range of fabrics and colours or mix and match them to create a unique atmosphere for your office. The backrest and seat cushions can be easily removed and swapped.

ARCIPELAGO



**LOUNGE & SOFT FURNITURE**

3 heights

Thanks to their flexibility and 3 different height options, ARCIPELAGO lounge benches are a great choice for spaces of any size and style. The high-back option will provide you with more privacy and acoustic comfort.

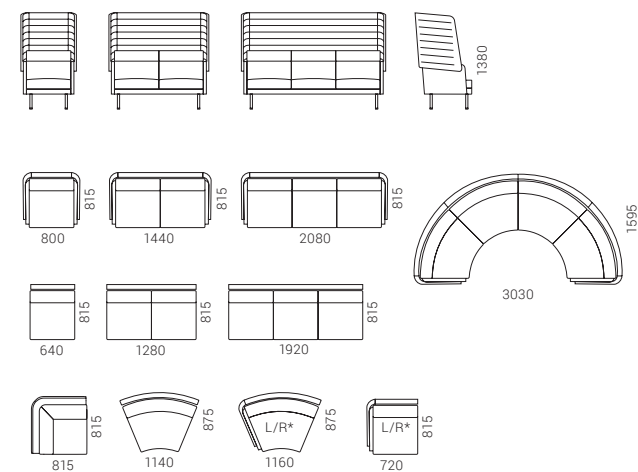
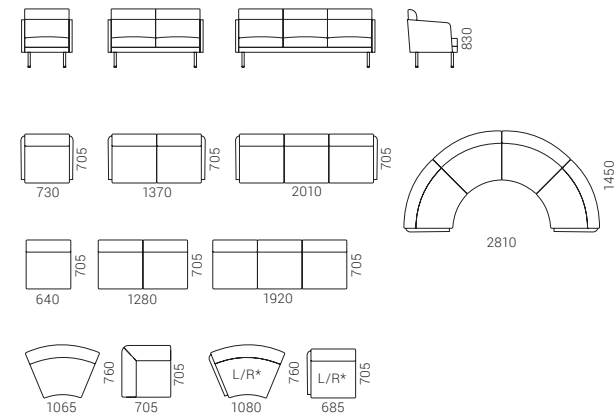
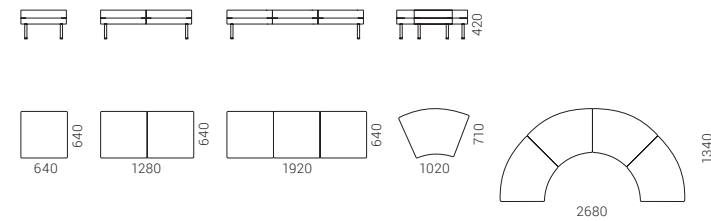

\* - left/right

336

Useful accessories

Lounge benches come with well-designed accessories. You can choose a table or armrest with or without an integrated power socket or USB fast charger. Both of these can be easily mounted in between the seats.

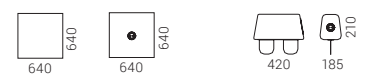

**LOUNGE & SOFT FURNITURE**









LOUNGE  
& SOFT  
FURNITURE

# JAZZ Chill Out

Design by Christina Strand and Niels Hvass

> 200  
ACOUSTIC  
FURNITURE

## Freedom of improvisation

JAZZ Chill Out is an easily customizable pouf system for any lounge or waiting area in your office. A wide selection of fabric, artificial, and natural leather finishes opens up unlimited possibilities to create the desired interior atmosphere.

340



## Convenient details for contemporary people

For the convenience of users, the poufs have an integrated plug or USB fast charging socket - an extremely practical solution for not only office workers but for visitors as well. Another functional highlight of this system is the metal table, which can be easily placed on the surface of the pouf to protect objects from falling.

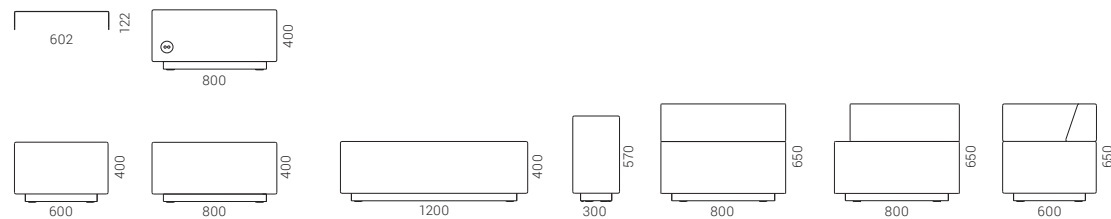

JAZZ Chill Out



341

JAZZ Chill Out



A true colour pallet  
at your office



GIRO pouf system is a great way to liven up any office environment and create the desired mood by choosing matching or contrasting colours. A wide selection of fabric, leather look and genuine leather is available for this pouf system upholstery. Small, lightweight, and mobile GIRO can be effortlessly rearranged in space.

342

## Customizable design

Variation of three different diameters and three different heights allows the user to choose the one that best suits their needs - it can be used both for sitting at a colleague's workplace or placed in the waiting and lounge areas. There are 2 base options available for GIRO system - with plastic glides or castors. Choosing plastic supports will create a more tidy office look while choosing castors will allow you to move the furniture around without much effort.

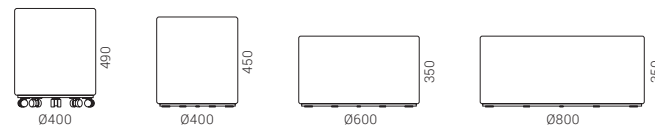

ERA  
C09

SYNERGY  
S63



# VEGAS

A temptation  
to relax

A curved shape, lower and wider  
seating area implies a welcoming  
invitation to have a seat for  
anyone passing by.

344



The chair shell can be upholstered with different  
fabric combinations, leather look, or genuine leather.  
Chromed steel sled frame base create a distinctive  
character and provide durability while plastic glides  
help prevent floor damage.

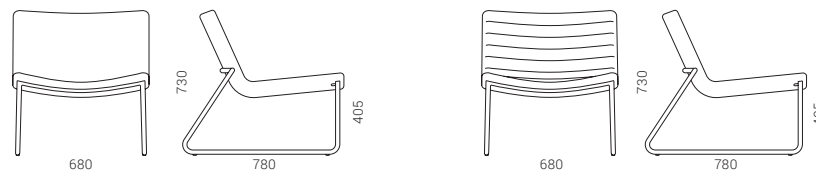

VEGAS

# CUMULUS

Design by Kazuko Okamoto



345

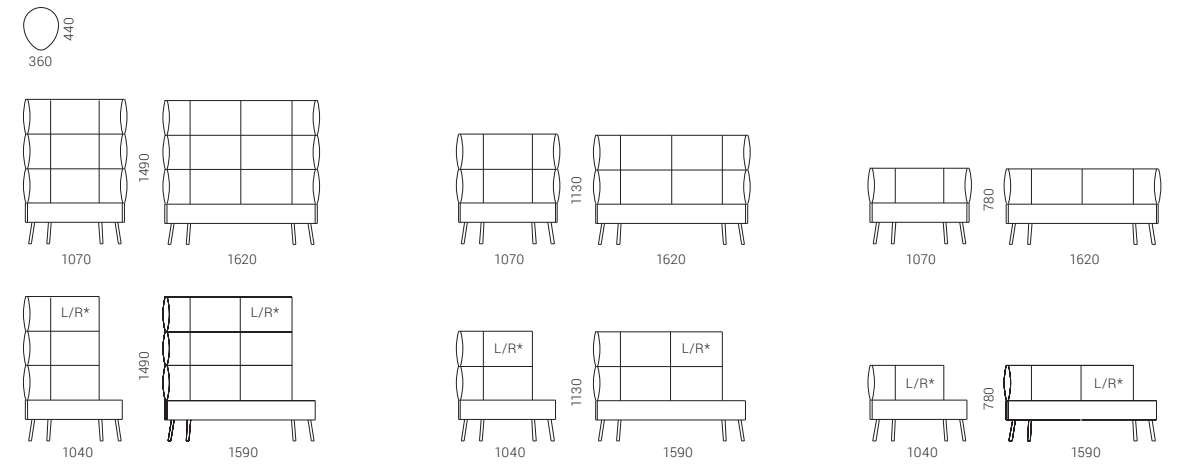

\* - left/right



CUMULUS



## Designed to bring comfort

It is a perfect fit for lounge and waiting areas or informal meeting spaces. The distinctive design of the chair is made to wrap itself around the user and provide not only a comfortable sitting experience but also coziness.

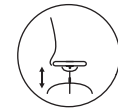

PNEUMATIC HEIGHT  
REGULATION

346



## Custom features for unique looks

TULA chairs are highly customizable as you can select individual colours for the front and back parts of the chair. You can even mix and match different materials for the separate parts of the upholstery. With our wide selection of fabric, leather look, genuine leather, the chairs can be adapted for a number of unique situations and looks.

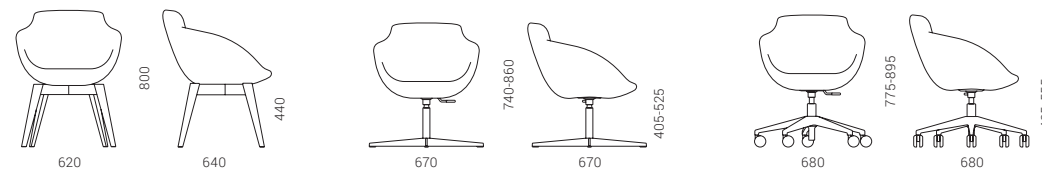



## Make your office stand out

This chair is a perfect combination of elegance and comfort. A charming silhouette creates a sophisticated look and a welcoming feeling that is why this chair will perfectly blend in any conference room or waiting area.

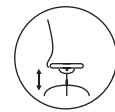

PNEUMATIC HEIGHT  
REGULATION

348

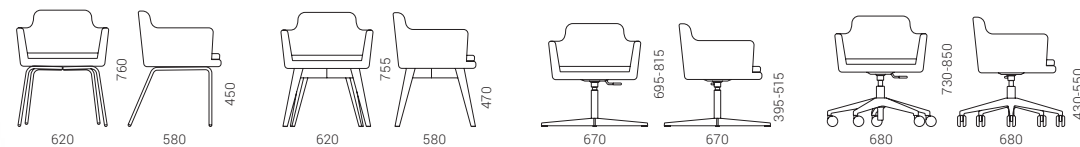



# MEG

A distinctive addition  
to your office

With its contemporary shape, MEG lounge chair will definitely find a place in any office space. A laconic design will suit those who appreciate a moderate style.

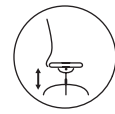

PNEUMATIC HEIGHT  
REGULATION

350

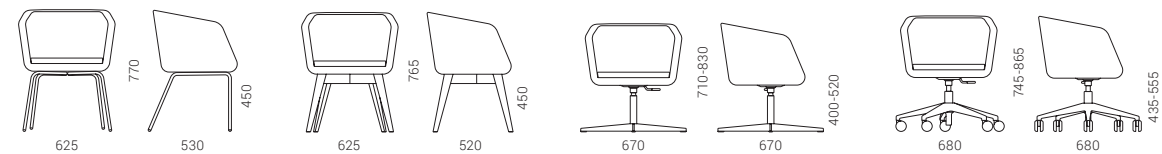

MEG

# LUNA

A proven design  
that lasts

Stylish and refined, this lounge chair represents a classic approach to the office design. A simple yet timeless look makes LUNA a wise choice.

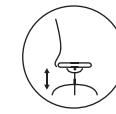

PNEUMATIC HEIGHT  
REGULATION

351

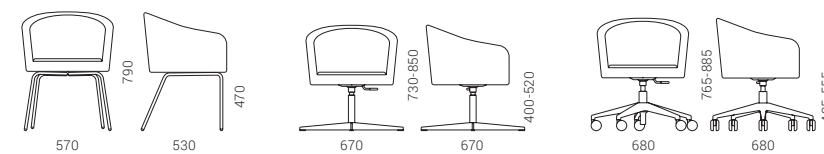

LUNA



# EXECUTIVE FURNITURE

352



**MOVE&LEAD**

> 354



**MOTION Executive**

> 360



**PLANA**

> 366



**AIR Executive**

> 370



**NOVA Executive**

> 374

353



# MOVE&LEAD

Design by Gediminas Juška

“

*Move! is a slogan of the modern man that represents the victory of mobility against stagnation, sloth and succumbing to negativity. A true modern leader is driven and open to innovation, a cosmopolitan dictating healthy lifestyle and a teacher who shapes his or her environment with dignity.*

Gediminas Juška

## Every detail matters

MOVE&LEAD is a top-quality product which stands out for its uncompromising standards of excellence in craftsmanship. Curved wooden surfaces are shaped employing traditional manufacturing methods and following highest quality standards. Parts of different materials are joined together with every detail in mind.

## Your best move!

It combines the best in ergonomics and cutting-edge technology and is designed for modern active leaders. The desk's height can be adjusted between 740 mm and 1300 mm, this allows you to stay on the move and be active even at your desk.

↑  
735 - 1300 mm

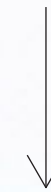

355



**EXECUTIVE  
FURNITURE**

Minimalism is  
the new luxury

Clean, elegant lines, smooth transitions and subtle combinations of materials are guaranteed to make a strong visual impact in any office. HPL Fenix finish, natural oak, ash or walnut veneer and polished stainless steel surfaces form a harmonious whole and create a sense of subtle luxury.

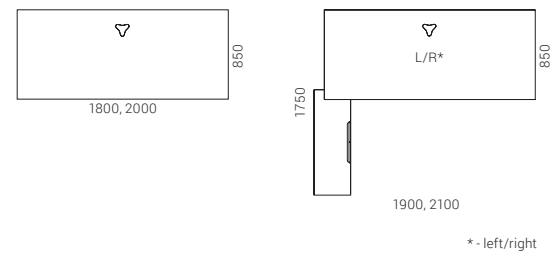
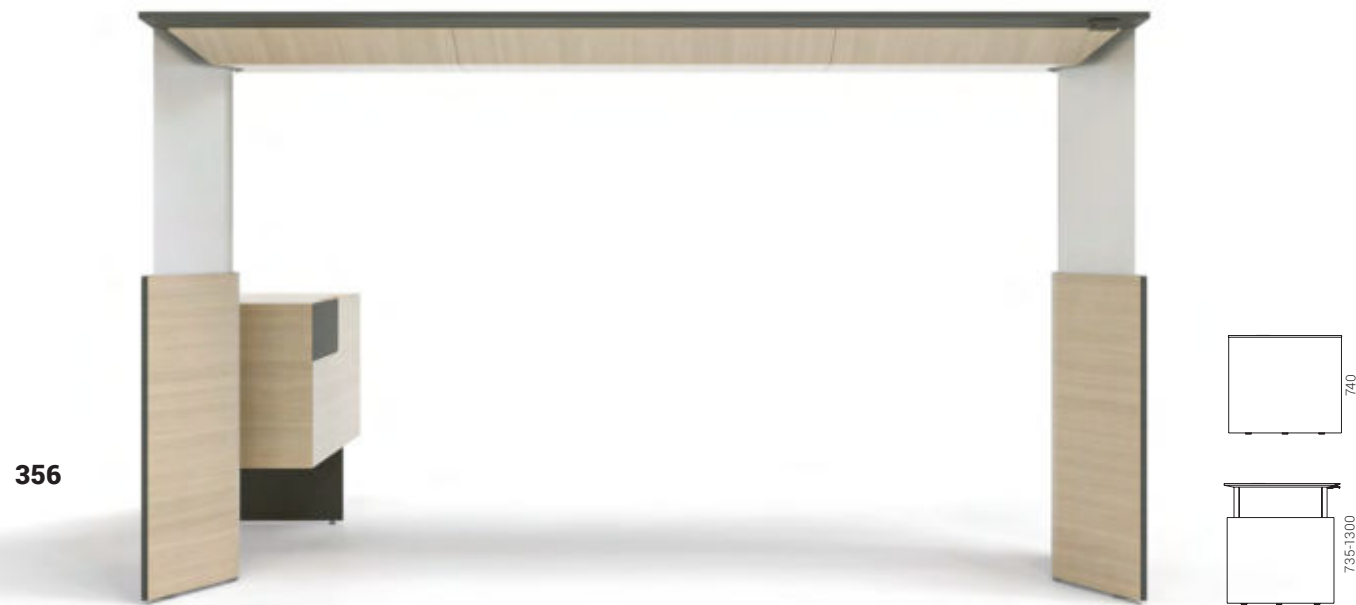

Declutter your  
workplace

The hidden wires can be accessed by opening an elegant minimalist lid. Wires and cables are routed through a subtle triangular-shaped hole with an original cover in a colour that matches that of the desktop or natural wood. MOVE&LEAD desk also has an in-built best-in-class Qi wireless charger (15W) for your smart devices.



**MOVE&LEAD**



Everything you need

Besides fixed-height or height-adjustable desks, MOVE&LEAD executive furniture system also includes storage solutions to keep your office essentials and personal belongings close at hand. The desk cabinet drawers with special inserts will ensure a well-organised workspace.

**357**

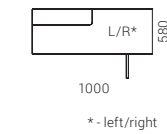



EXECUTIVE  
FURNITURE

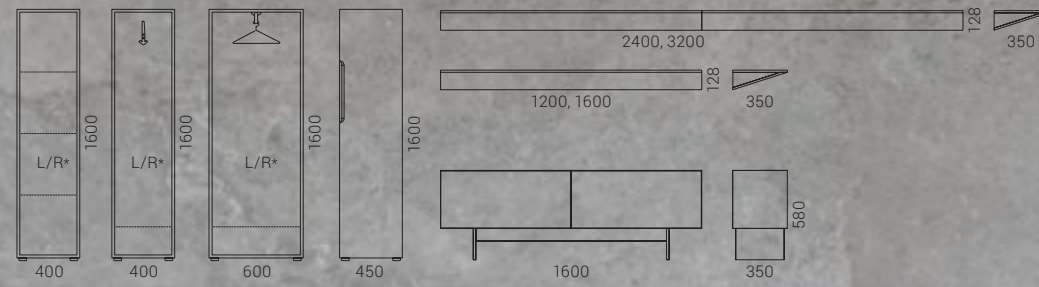

\* - left/right





# MOTION Executive

> 28  
SIT-STAND  
DESKS

Modern desk for  
an active leader

MOTION Executive is a system of electric height adjustable desks, designed for a workplace of a dynamic leader. This desk is a combination of modern elegance and thoughtful functionality.

360



Modern  
sophistication

Panel legs hide the space under the desk giving more visual privacy. The feeling of elegance and sophistication is strengthened by the huge size of the top, which is designed for comfortable work. MOTION Executive can have even 36 colour combinations and allows you to create a desk which will suit your interior and personality best.





## Easy to use

You can adjust the height of the desk by simply pressing the button or with a remote control application on your smart device. You can save the most comfortable positions and get a reminder to change your body position: to stand up or sit down.

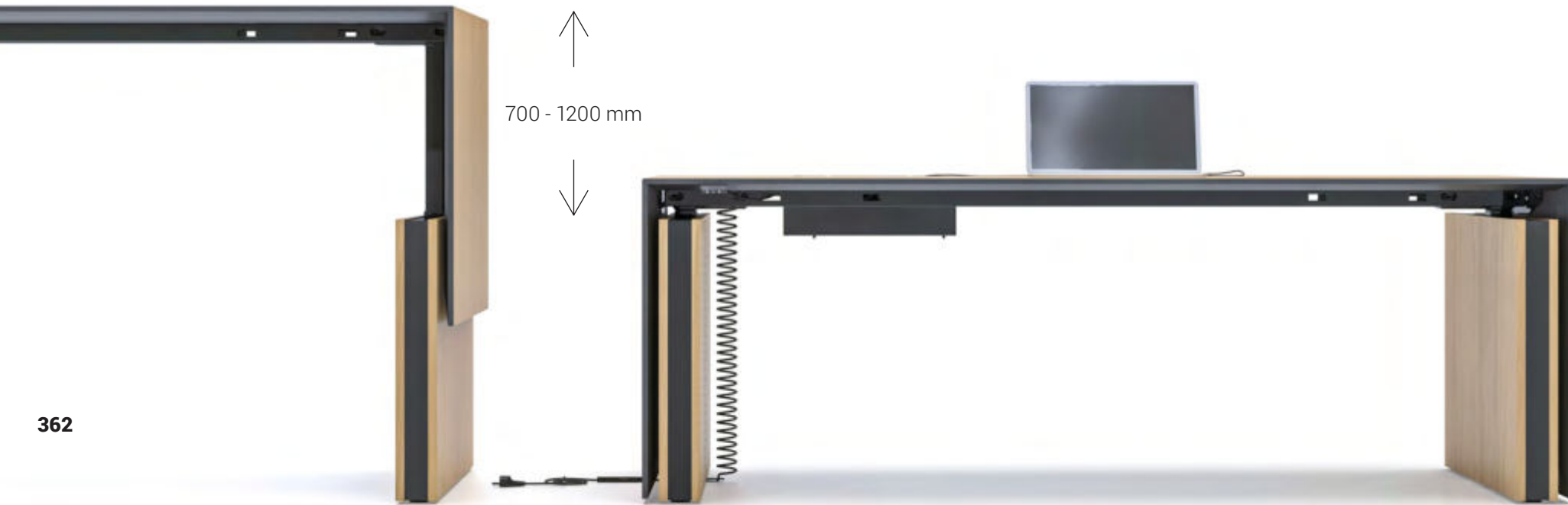

362

↑  
700 - 1200 mm  
↓

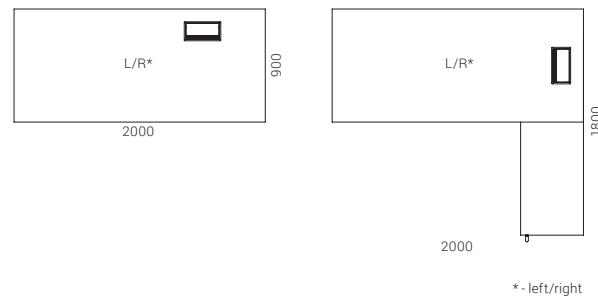

## Reveal your style and individuality

According to your needs, you can choose from two MOTION Executive models: Executive desk made of veneer is designed for those who appreciate naturalness. The top has a subtly chamfered edge, while side panel wraps the desk and makes it look more united and modern. MOTION Executive desk with melamine finish does not have a side panel and looks more simple and modest.



## Obstacle avoidance system

MOTION Executive desk is integrated with a sensitive gyroscope-based anti-collision unit that senses both hard and soft obstacles.

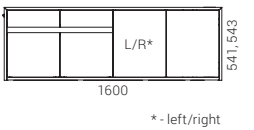

363

## Functional storing

The range consists of several pedestals of different sizes and drawers with or without metal file bars. An easily reachable drawer can be situated in the upper corner of the desk, it is convenient for storing your valuables and can be locked for safety.









A modern collection  
of premium furniture

## Wide range

PLANA tables come with an option of fixed or separate pedestals and many other different storage solutions, such as wardrobes or open shelf units. Modesty panels can be added for a higher sense of privacy, while a table extension can create a space to have meetings right at your desk.

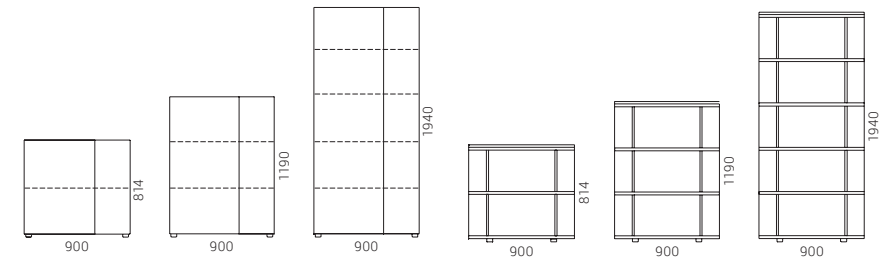
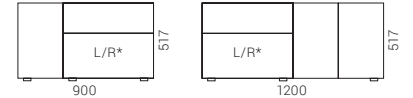

\* - left/right

366

367

The Italian design of the tables is based on the harmony of straight and curved lines. The elegant three-part curved steel legs are crafted using advanced technology and are the ultimate distinctive feature of the system.

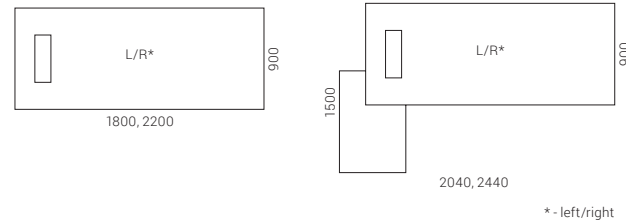

\* - left/right

## Quality in the details

The tables come with soft closing grommet, beautifully framed in metal and concealing the box for wire management. PLANA storage features subtle accents such as different panel thickness combinations, lowered top panel.





EXECUTIVE  
FURNITURE

EXECUTIVE  
FURNITURE



PLANA

PLANA



# AIR Executive

Design by Gediminas Juška

> 76  
DESKS

> 100  
CONFERENCE  
& MEETING  
TABLES

## Two thicknesses

The tables are available in two different desktop thicknesses. The solid 120mm desktop gives the table an air of sophistication and will become the focal point of any office. The 25mm desktop is a universal choice for minimalistic offices, its pleasingly simple design will accentuate the unique structure of the legs.

370

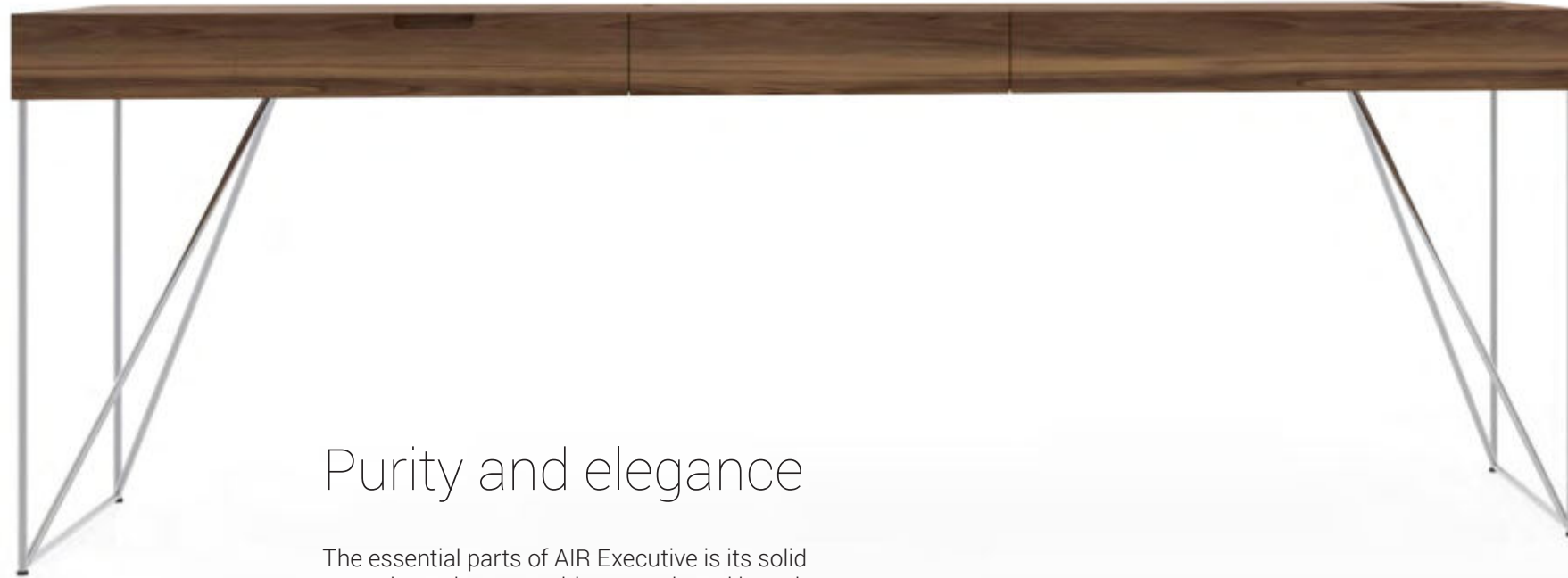

## Purity and elegance

The essential parts of AIR Executive is its solid natural wood veneer table top and steel legs that ensure not only the elegant feel of the table, but also its stability. The integrated drawers are lined with high quality natural leather.



371

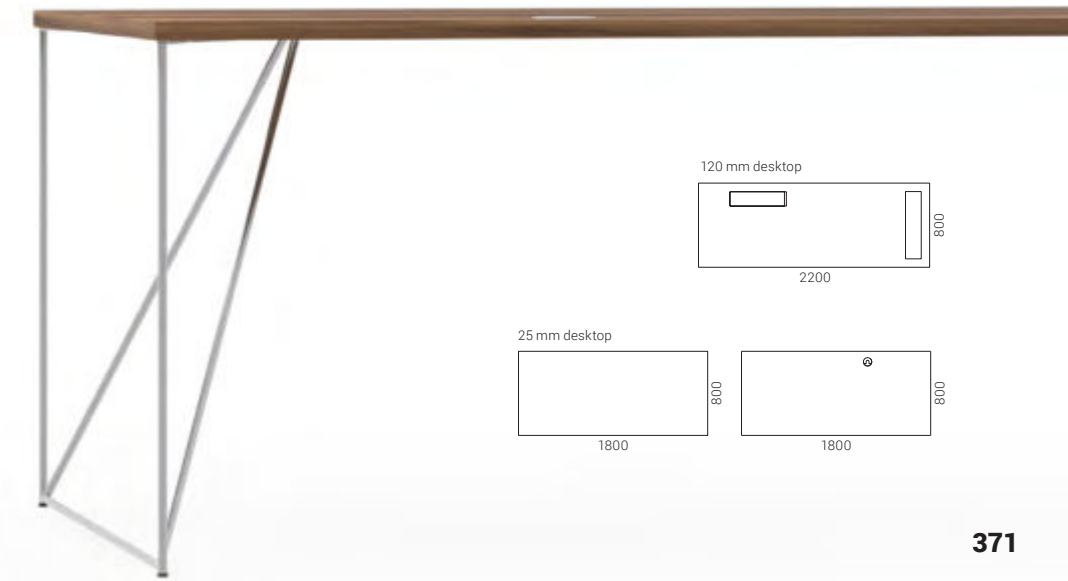

## Hidden wiring

Steel table legs are designed in a way that hides all the cable wiring and allows you to keep all the unnecessary items out of your main workspace.





EXECUTIVE  
FURNITURE

372



373

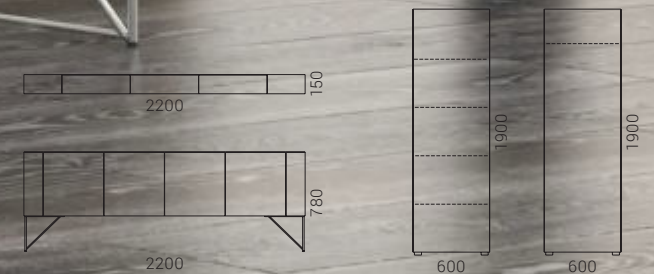



# NOVA Executive

For the modern manager  
who appreciates the classics

The NOVA Executive desk will fit harmoniously into an open-plan office and, together with the cabinet, will be perfect for an elegant executive office. Natural veneers will help to create a luxurious look.

374



The Executive desks are available with two types of legs: regular U-shaped legs are a universal design solution that fits in any office while O-shaped legs are for those who want to add a modern touch to their space.

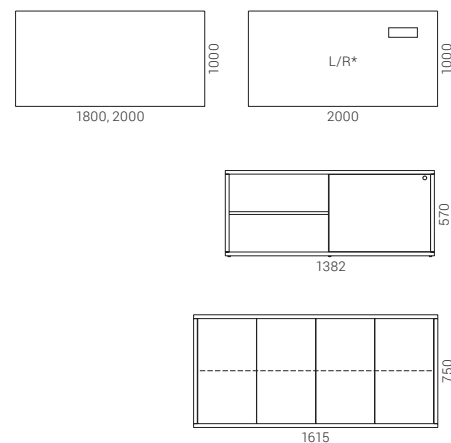
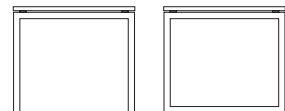

\* - left/right



> 68

DESKS

> 98

CONFERENCE  
& MEETING  
TABLES

> 118

HIGH  
TABLES

> 124

OCCASIONAL  
TABLES



# RECEPTION FURNITURE



ICE  
> 378



DOMINO  
> 384



NOVA  
> 390



COSY  
> 392



TERA  
> 393



## Minimalistic design

The strict lines of the ICE reception unit create an impeccable shape, suitable for both fancy and ascetic office interiors.

378

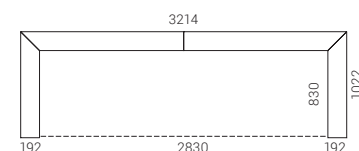
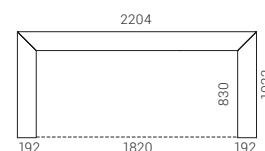

## Subtle combinations

Depending on your vision for the interior, choose between a cozy melamine, or a luxurious veneer finish. Various front and top combinations are also available. Using the same finish on the top, base and front will create a solid and minimalistic reception unit, which will be as clean and smooth as ice. On the other hand, introducing a different-coloured top or decorative inserts will allow you to subtly reveal the elegance of this reception unit.



## Ergonomic workspace

The ICE reception unit conforms to the needs of an ergonomic workspace and fits either one or two workstations – a perfect match for NARBUTAS sit-stand or fixed-height desks.

380



381





RECEPTION  
FURNITURE

RECEPTION  
FURNITURE



ICE

ICE



The rules are simple:  
never stop creating!

DOMINO is a unique piece of furniture that will enable you to create a one of a kind design for your reception in just 4 simple steps. There are no two identical rounds in the game of dominoes, just like there are no two identical DOMINO pieces of furniture!

Easy way to create  
unique reception  
furniture

Firstly, choose the furniture base that suits you best from a range of nine different options. Secondly, combine two thicknesses of exterior panels (18 and 31 mm). Thirdly, choose panels in multiple colours and combine different coatings: upholstery, melamine and natural veneer. Lastly, create your own custom pattern using panels available in 200, 400, 600 and 800 mm sizes.

384

385



## Cosy atmosphere and acoustic comfort

For your DOMINO setup, we recommend using MODUS acoustic screens which will allow you to maintain consistency in your interior style and provide employees with a sense of privacy.

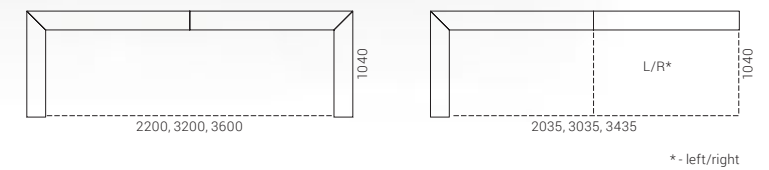
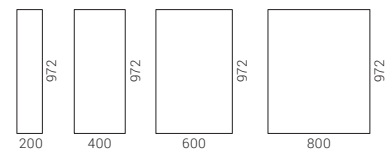
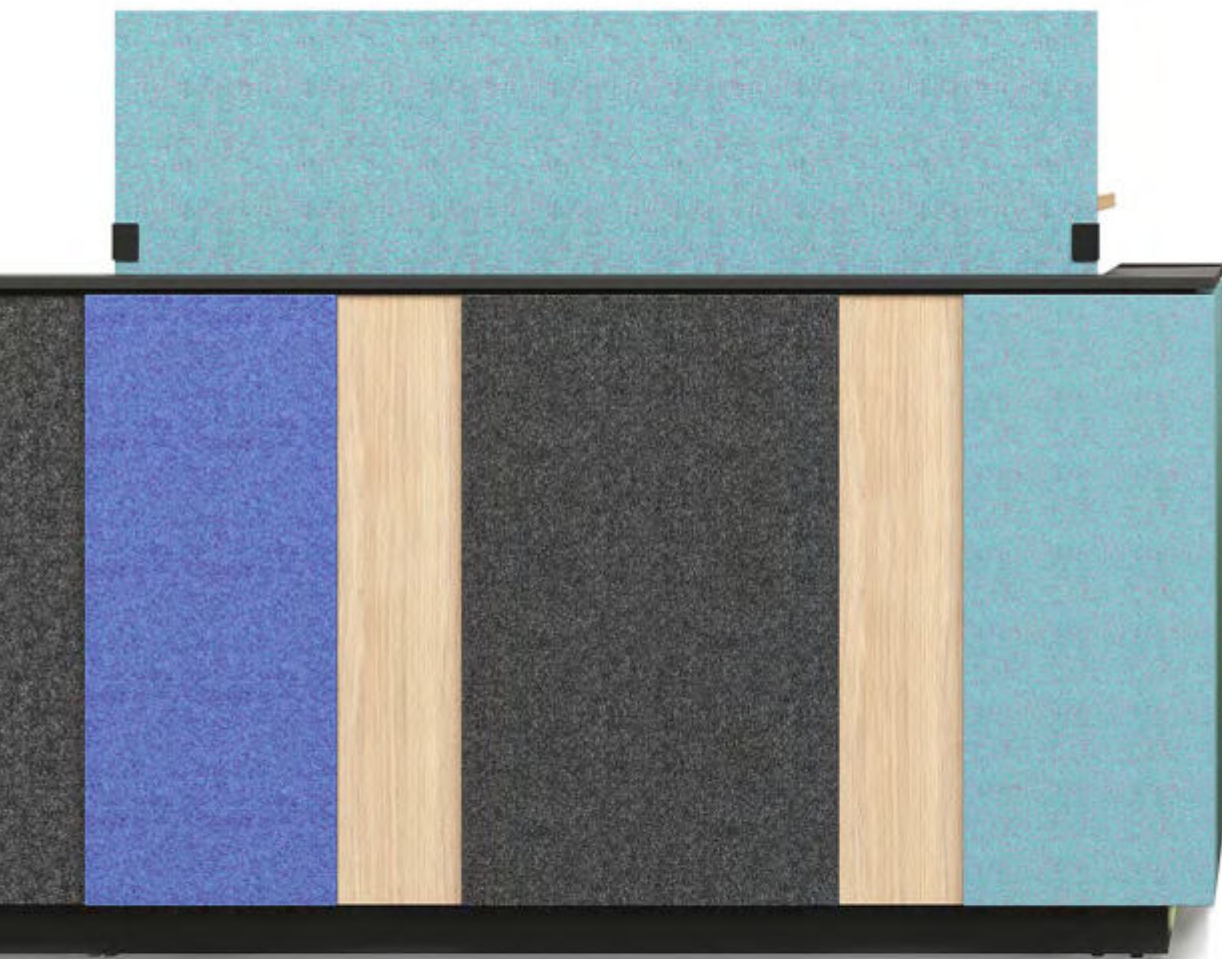

## Ergonomic workplace

You can create an ergonomic workplace using both regular or sit-stand desks which can be adjusted to a chosen height by employees.

## Cable management solutions

DOMINO reception furniture has all the cable management solutions that are necessary for an ergonomic workplace. Electrical and internet cables will not get in your way and your desk area will be clutter-free and aesthetically pleasing to the eye.











390

## Varying forms

Our reception furniture sections are available in different forms. Choose a combination best suited for your office layout.

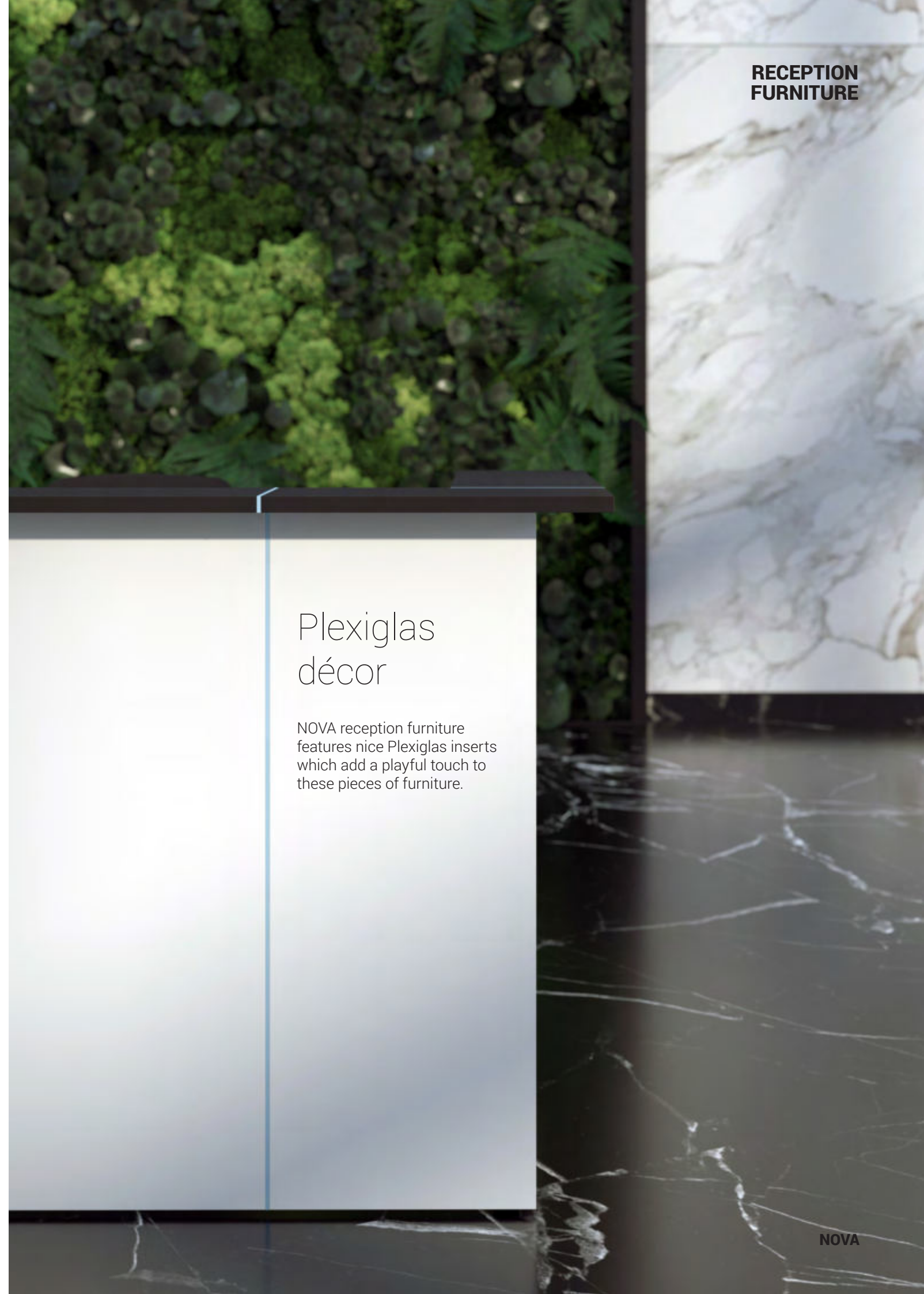
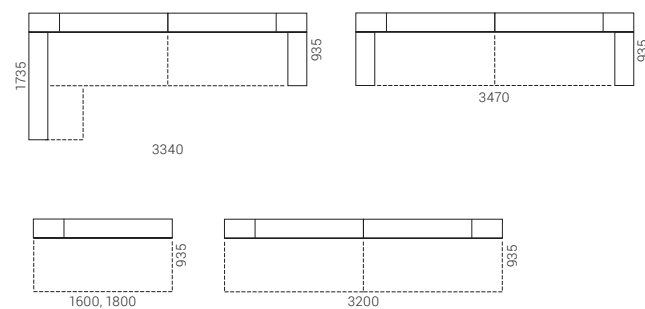

## Plexiglas décor

NOVA reception furniture features nice Plexiglas inserts which add a playful touch to these pieces of furniture.



# COSY



392

A clean, modern look with no sharp corners on the front side will create a friendly and cosy atmosphere for your visitors. A compact-looking reception is equipped with a 2000mm long table which provides plenty of working space and has many niches for storage. This product also features high-quality impact-resistant materials for better durability.



# TERA

This modular reception furniture system offers modules in different forms and sizes and is ideal for reception areas of various offices.

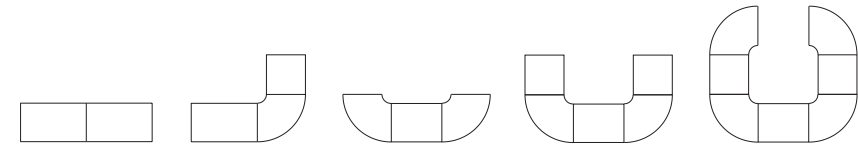

393

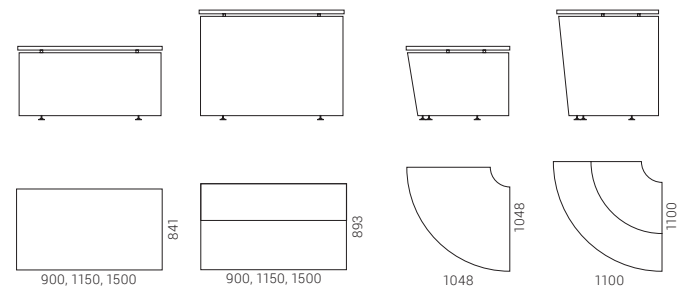



# CUSTOM-MADE SOLUTIONS

CUSTOM-MADE SOLUTIONS

More room for creativity

We are flexible and offer our customers the service of designing and producing custom furniture. We will adapt the furniture to different needs, bringing every client's vision to fruition.

Customised production can be of two types: making changes to standard furniture according to the customer's needs; or creating a completely new and unique product. The engineers and designers of custom furniture must make sure that the customer's ideas are fulfilled down to the smallest detail, while paying special attention to the functionality of the furniture.

NARBUTAS has a wide range of production facilities for large-scale production, as well as for small batches of furniture or one-off products. This makes it possible to work with many different materials, to produce furniture with curved shapes and metal parts of varying complexity, as well as soft furnishings and acoustic furniture. The plant's modern equipment is versatile, so the range of possibilities is extremely wide.

394



DESKS AND TABLES

> 396



SEATING

> 402



STORAGE

> 398



RECEPTION FURNITURE

> 404



ACOUSTIC SOLUTIONS

> 400





# DESKS AND TABLES

## Changes to standard furniture

The changes you can make to the product:

- Size;
- The location and shape of the cut-out in the desktop;
- The desktop finish and colour;
- The colour of the desk legs.

## Custom-made furniture

Our technical capabilities allow us to produce exclusive desks, meeting tables or high/bar tables. We can design furniture with different shapes and finishes that are not available in our standard product range.

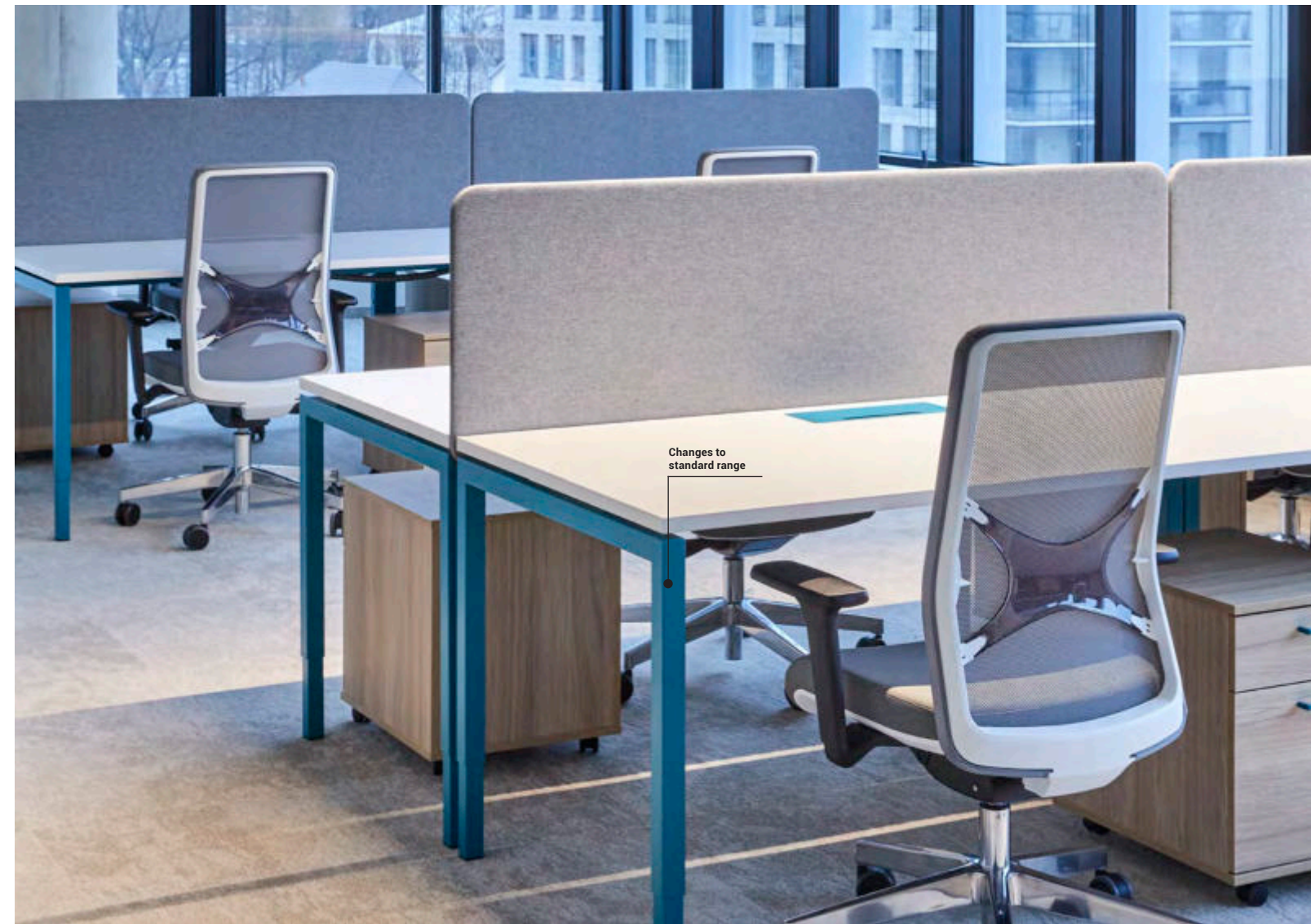



# STORAGE

## Changes to standard furniture

The changes you can make to the product:

- Size;
- Type and colour of handles;
- Storage unit finish or colour;
- The form of delivery, i.e. you can order an assembled storage unit.

## Custom-made furniture

Storage units often take up a significant amount of space in an office, so it is essential that the furniture is both practical and stylish. Recessed storage solutions with integrated lighting and acoustic panels will create a cosy environment. And recesses with integrated coffee, tea or even ice-cream machines are sure to become a centre of attraction in the modern office.

398

Changes to  
standard range





# ACOUSTIC SOLUTIONS

## Changes to standard furniture

The changes you can make to the product:

- Size;
- Shape;
- Colour;
- Pattern.

## Custom-made furniture

Taking into account the current trends in office design, we offer a range of acoustic products that are easily adaptable to different offices. The experience we have gained in the development of projects of various complexity evolves into exclusive solutions.

By listening to our customers' expectations, we have developed acoustic pods that have become unique semi-private spaces for individual work or meetings. We can also produce large enclosed acoustic rooms with an additional ancillary space.

400

Changes to standard range





CUSTOM-MADE  
SOLUTIONS

# SEATING

## Changes to standard furniture

Create different looks with NARBUTAS seating. Choose from a wide range of upholstery, artificial and genuine leather collections and shades. We understand that sometimes exclusive interiors require unconventional solutions or shades. That is why we make it possible to choose custom-made upholstery materials.

We can also produce JAZZ Chill Out poufs in different sizes, so that you can easily fit them into niches or other spaces with custom-made dimensions.





CUSTOM-MADE SOLUTIONS

# RECEPTION FURNITURE

## Changes to standard furniture

The changes you can make to the product:

- Size;
- Shape;
- Colour;
- Finish.



## Custom-made furniture

Customer reception areas usually require customised solutions that can convey the unique image of the company's brand. Thanks to our modern production facility capacities, we can manufacture customised reception furniture with high pressure laminate (HPL), perforated metal or even PET felt finish.





## FINISHES

### Melamine

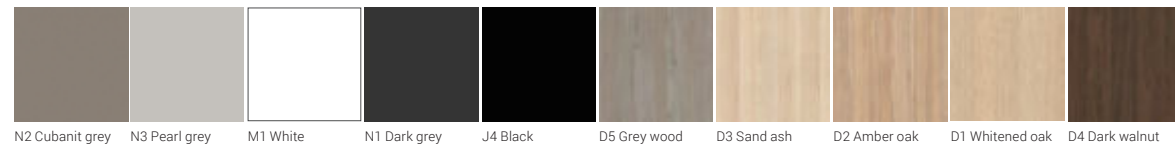

### HPL

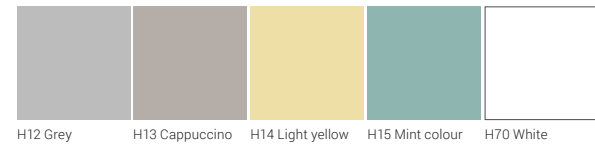

### HPL Fenix

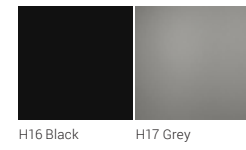

### Solid wood

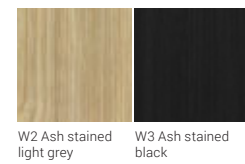

406

### Veneer

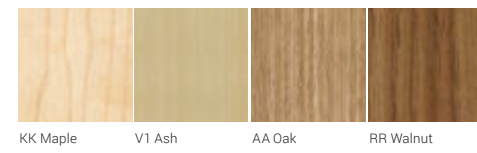

### Plexiglas®

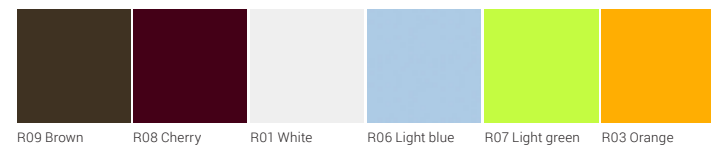

### PET felt

100% Polyester fiber (>50% post-consumer polyester)

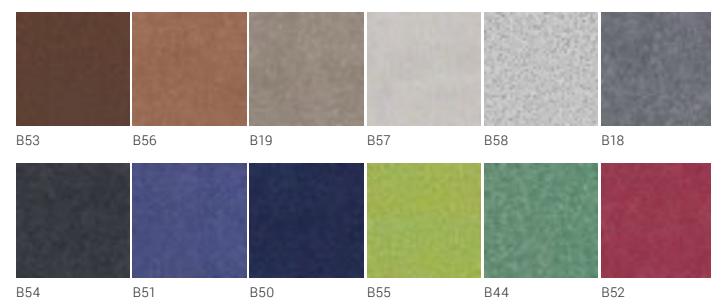

### Metal

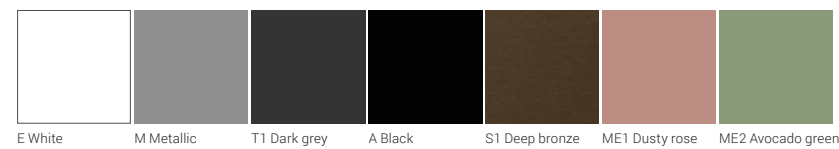

## FINISHES

### Synergy

95% Virgin Wool, 5% Polyamide



### Velito | Velito Presto

88% Wool, 12% Polyamide

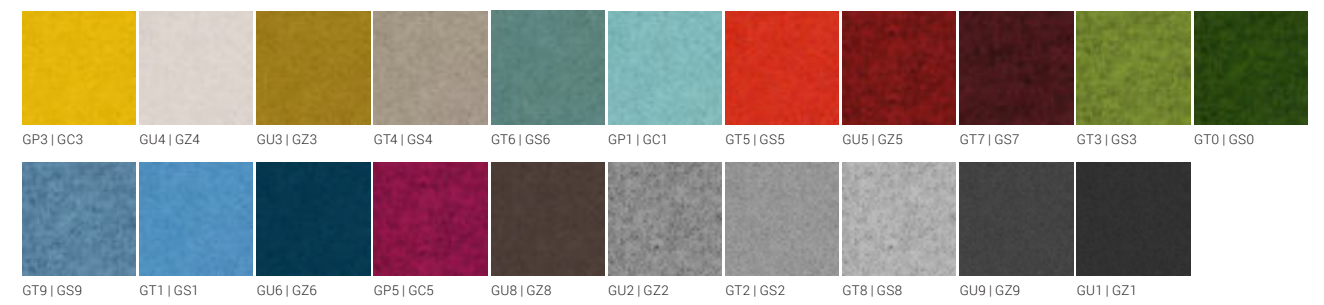

### Step | Step Melange

100% Trevira CS® Flame Retardant Polyester

407

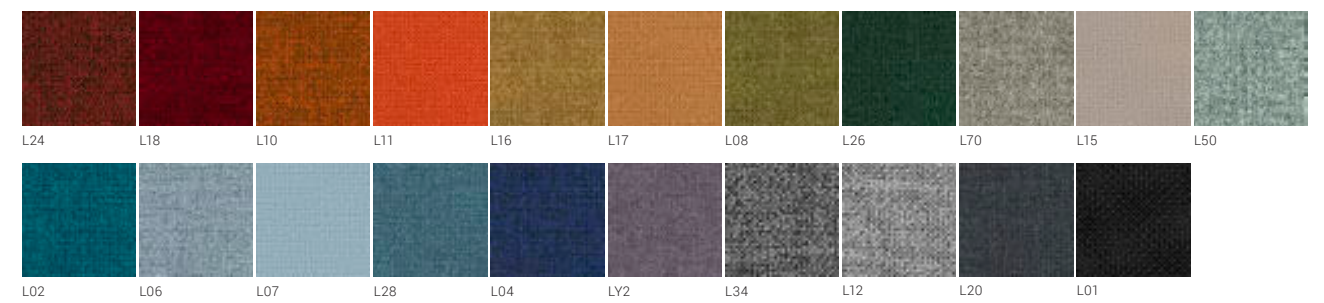

### Era

100% Polyester

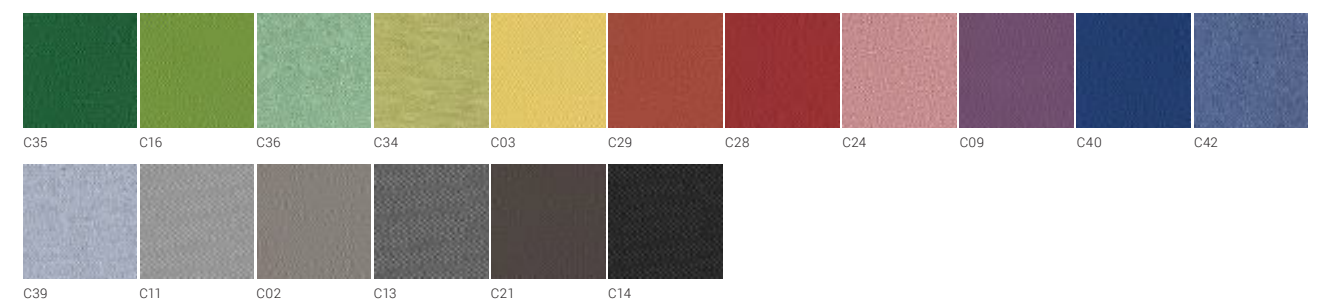



FINISHES

Berta

100% Polyester

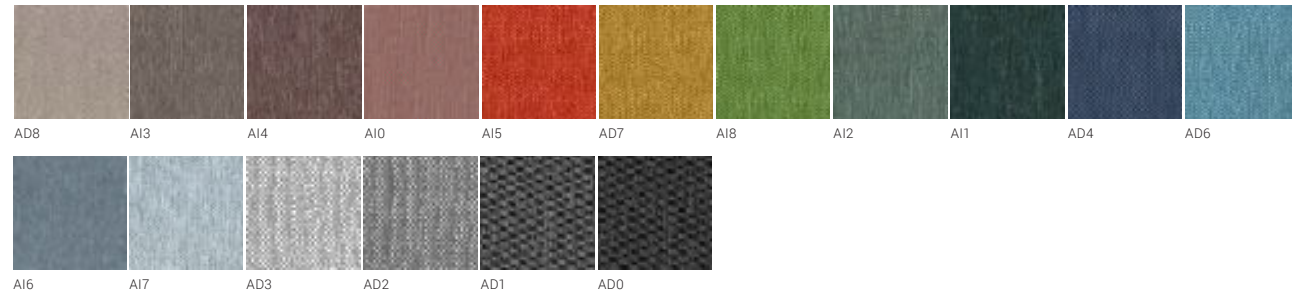

Xtreme Plus

100% Recycled Polyester

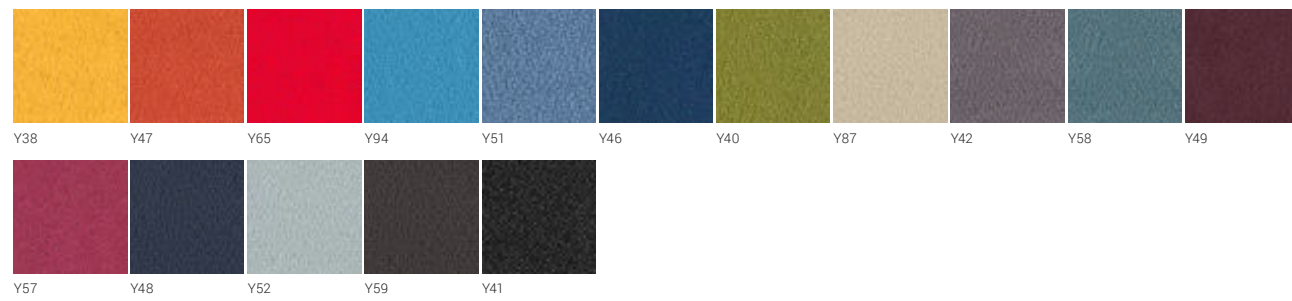

408 Bondai

100% Polyester



Lucia

100% Recycled Polyester



Valencia C5

Vinyl / Urethane Topcoat

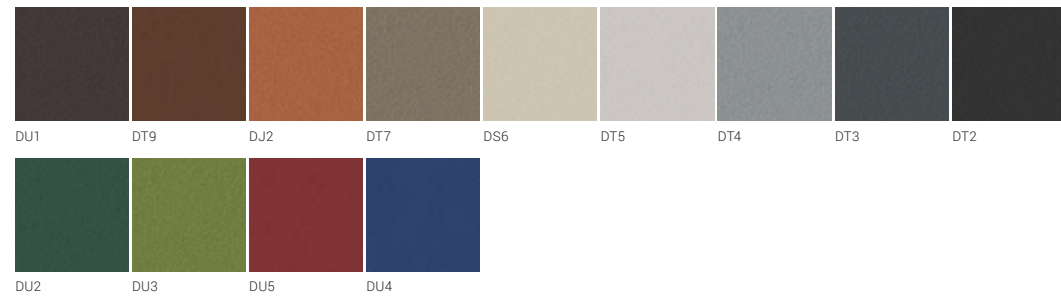

FINISHES

RNN

21% PES, 31,5% COT, 47,5% PU



DNN



Real leather



Runner mesh

100% Polyester (20% Recycled Polyester)

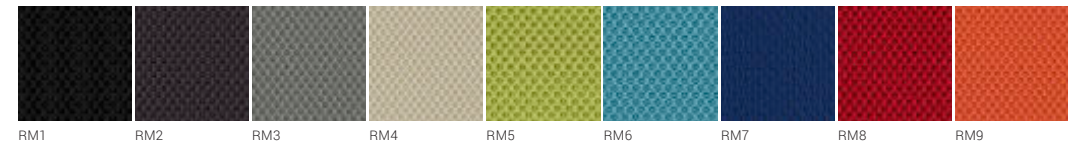

Knitted mesh

100% Polyester

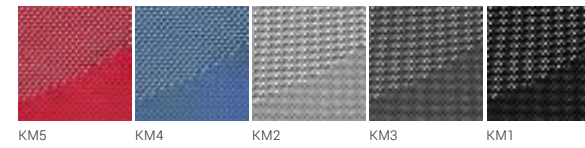

Micro

100% Polyester 409

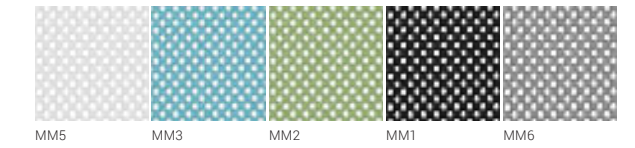

PM

70% PVC, 30% PES



GM

100% Polyester

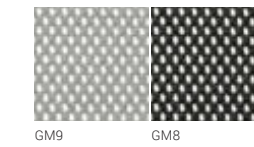

Plastic

100% Plastic



100% Recycled Plastic

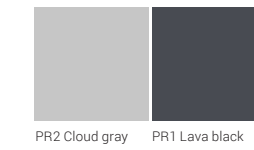



# Definition of icons



## TILT MECHANISM

The backrest and seat base are linked. When user leans back the whole chair tilts.



## KNEE TILT MECHANISM

The backrest and seat base are linked. When user lean back the whole chair tilts. This mechanism allows user to tilt back while the feet remain on the floor, no pressure on the back of the shin.

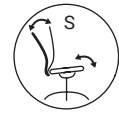

## SYNCHRONOUS MECHANISM

The seat tilting angle is smaller than the tilting angle of the backrest, so that the chair would be more comfortable. This mechanism allows user to tilt back while the feet remains on the floor, no pressure on the back of the leg.



## WEIGHT-SENSITIVE MECHANISM

Mechanism automatically adapts to the user's weight and movement when leaning back.



## TENSION ADJUSTMENT

This adjustment allows user to control the rate and ease with which the chair reclines for different weights and strengths.



## LOCKING POSITIONS

The backrest of the chair has multiple locking positions with different angles for comfortable working, reading or resting.

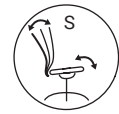

## BACKREST TRAVEL LIMITATION

The backrest travel is limited to 3 positions with back locking in the upright work position.

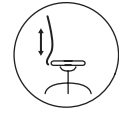

## BACKREST HEIGHT ADJUSTMENT

The backrest height can be individually adjusted according to the height of the user.



## SLIDE SEAT

This adjustment helps the user to regulate the distance between the backrest and front edge of then seat, thus providing optimum support for the upper thighs. Correctly adjusted seat depth helps user to maintain proper back support, while distributing the weight evenly across the seat cushion.

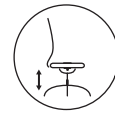

## PNEUMATIC HEIGHT REGULATION

This adjustment allows the user to change the height of the seat. Pneumatic mechanism uses pressurized air to lift or lower the seat.

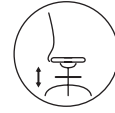

## HEIGHT ADJUSTABLE FOOTRING

The footring of the chair can be adjusted in height for the comfortable position of user's feet and legs without depending on the chair height position. It helps to maintain a correct seating position and avoid unpleasant back and neck pain.

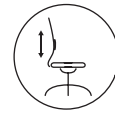

## ADJUSTABLE LUMBAR SUPPORT

The lumbar support can be adjusted in height and depth (depending on the chosen chair type). Adjustable lumbar support can be adapted to user's individual curve of the spine. It helps to reduce the muscle strain and protect from the back pain.



## LUMBAR SUPPORT

The lumbar support is mounted into the backrest and helps to reduce the muscle strain.



## HEADREST

This additional part of the task chair helps to reduce tension in your neck muscles, provides support and comfort to the head and neck while in a reclined position.

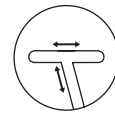

## ADJUSTABLE ARMRESTS

Depending on the chair type armrests are adjustable in two, three or four directions (2D, 3D, 4D): height, width, the pad moves forwards and backwards or is rotatable. Height adjustment takes the strain off the neck muscles. Width adjustment and rotation allows the user to position the armrest in proper distance from the body and helps finding the most comfortable support angle.



## WRITING TABLET

Rotatable. It allows users to put their notebooks, laptops or tablets upon.



## STACKABLE

Chairs can be easily stacked one onto another. Therefore, they are perfect for offices with low storage space.

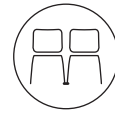

## CONNECTORS

Allow linking chairs in orderly rows.

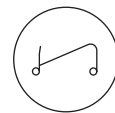

## TROLLEY

By using the trolley, you can easily store or move stackable chairs from one place to another.

narbutas

410

## Connect with us



## Work with us



Scan and find all useful links

© "Narbutas International", 2023

UAB "Narbutas International" reserves the right to change product information in this catalogue without prior notice.



narbutas



EN