



**MODULAR**

**LA NOSTRA STORIA,  
LA RICERCA DEL COMFORT  
DAL 1965.**

*OUR STORY,  
THE PURSUIT OF COMFORT  
SINCE 1965.*



**C**alia Italia, fondata a **Matera** nel **1965**, è l'azienda più antica del Distretto del Mobile Imbottito della Basilicata. Progetta, realizza ed esporta in tutto il mondo divani e poltrone in pelle e tessuto rinomati per l'**artigianalità**, la **cura dei dettagli**, l'attenzione per il **design** e l'inconfondibile **comfort**.

Puntando sulla valorizzazione del proprio territorio, investendo in ricerca e tecnologia, sviluppando la capacità logistica, l'azienda negli anni non ha mai smesso di crescere, diventando con la direzione artistica e creativa di **Saverio Calia**, e la strategia commerciale di **Giuseppe Calia**, una delle realtà più importanti e riconosciute al mondo nella realizzazione di "mobili imbottiti".

Grazie al lavoro di oltre **1500 persone** del territorio murgiano, Calia Italia realizza quotidianamente più di **1000 sedute**, con oltre **50 nuovi modelli** ogni anno, in **40 diversi rivestimenti** di pelli e tessuti, con più di **400 varianti** di colore per incontrare e soddisfare tutte le esigenze. Da un **magazzino interamente automatizzato** tra i più grandi d'Europa, il comfort pensato e realizzato a Matera raggiunge tutte le latitudini del mondo (dall'Europa all'America, dal Medio all'Estremo Oriente) per essere scelto ogni giorno in più di **90 paesi** da oltre **1000 persone**.

*Calia Italia, established in **Matera** in **1965**, is the most ancient company of the Upholstery Furniture District in Basilicata. The company designs, manufactures and exports worldwide sofas and chairs in leather and fabric, known for their outstanding **craftsmanship**, **care for details**, attention to **design** and unmistakable **comfort**. With the constant aim of promoting the territory, investing in research and technology and developing its logistics capacity, the company has never stopped growing over the years, thus becoming - under **Saverio Calia's** artistic and creative direction and **Giuseppe Calia's** commercial strategy - one of the most renowned companies in the production of upholstered furniture worldwide.*

*Thanks to the efforts of over **1,500 people** working in the Murgia area, Calia Italia guarantees a daily production of over **1,000 seats** a day, developing more than **40 new models** per year, in **40 different covers** both in leather and fabric available in over **400 colors**, in order to meet and fulfill all customers' needs. Calia Italia's comfort, conceived and made in Matera, is stored in one of the largest **automated warehouses** in Europe to be delivered to any place in the world (from Europe to America, from Middle to Far East) and is chosen every day in more than **90 countries** by over **1,000 people**.*



Matera, Sasso Barisano

# YOUR COMFORT EXPERIENCE

Con la Modular Collection Calia Italia inaugura una nuova concezione dell'interior design: "lo spazio diventa tuo". Il divano è un oggetto dinamico, flessibile, creato per essere personalizzato da chi lo sceglie: sedute, chaise longue, pouf e versioni recliner rifiniti su tutti i lati possono essere composti e scomposti all'infinito, mentre la vasta gamma di colori e forme permette di dare al modello il proprio stile e carattere. Il prodotto viene ideato, progettato e realizzato in azienda, ma trova la sua massima espressione quando entra nell'ambiente casa e si immerge in una dimensione fatta di design e di vita, nella quale ognuno è progettista del proprio spazio e della propria comfort experience.

*The 'Modular Collection' sees Calia Italia inaugurate a new concept of interior design: 'Lo spazio diventa tuo' (becoming your space).*

*A sofa is a dynamic, flexible object and it is created to be customised by those who choose it. Seats, chaises-longues, footstools and recliner versions (finished on all sides) can be composed and disassembled endlessly, while a wide range of colours and shapes can allow you to give a model its own style and character. The product is conceived, designed and manufactured by the company but it finds its maximum expression when it enters the home environment and is plunged into a dimension of design and life. It is a dimension in which everyone is the designer of their own space and comfort experience.*

LAZY	07
MODULA	17
ELISEO	27
TANGO	37
HIP HOP	47
FOX TROT	57
JOHNNY	67



# LAZY

EXPERIENCE



Design: Studio Pastina

Lazy è il divano dalle linee morbide e accoglienti che si ispira all'oggetto comodo per eccellenza: il cuscino. La semplicità delle forme nasconde un design ricercato e una grande attenzione ai dettagli: il modello prevede una versione recliner con comando touch per sollevare la pediera aumentando la profondità della seduta. Un ampio pouf angolare consente di azionare simultaneamente i meccanismi di entrambe le poltrone adiacenti e può trasformarsi in una comoda seduta grazie alla spalliera mobile zavorrata posizionabile a piacimento. Con tutte le sue possibilità, la comfort experience di Lazy è un vero e proprio viaggio che può portare ovunque. Nel 2020 Lazy ha vinto il German Design Award nella categoria Excellent Product Design.

Design: Studio Pastina

*Lazy is a sofa with soft and welcoming lines and it is inspired by the comfortable object par excellence: the cushion. The simplicity of the shapes hides a refined design and a great attention to detail. The model includes a touch control recliner version that can lift the footboard and increase the depth of the seat and there is also a large corner footstool that allows for simultaneous operation of the mechanisms of both adjacent armchairs. Indeed, it can be transformed into a comfortable seat thanks to the ballasted mobile backrest that can be positioned as desired. With all its possibilities, the comfort experience of Lazy is a real journey that can take you anywhere. In 2020 Lazy wins the German Design Award in the category of Excellent Product Design.*



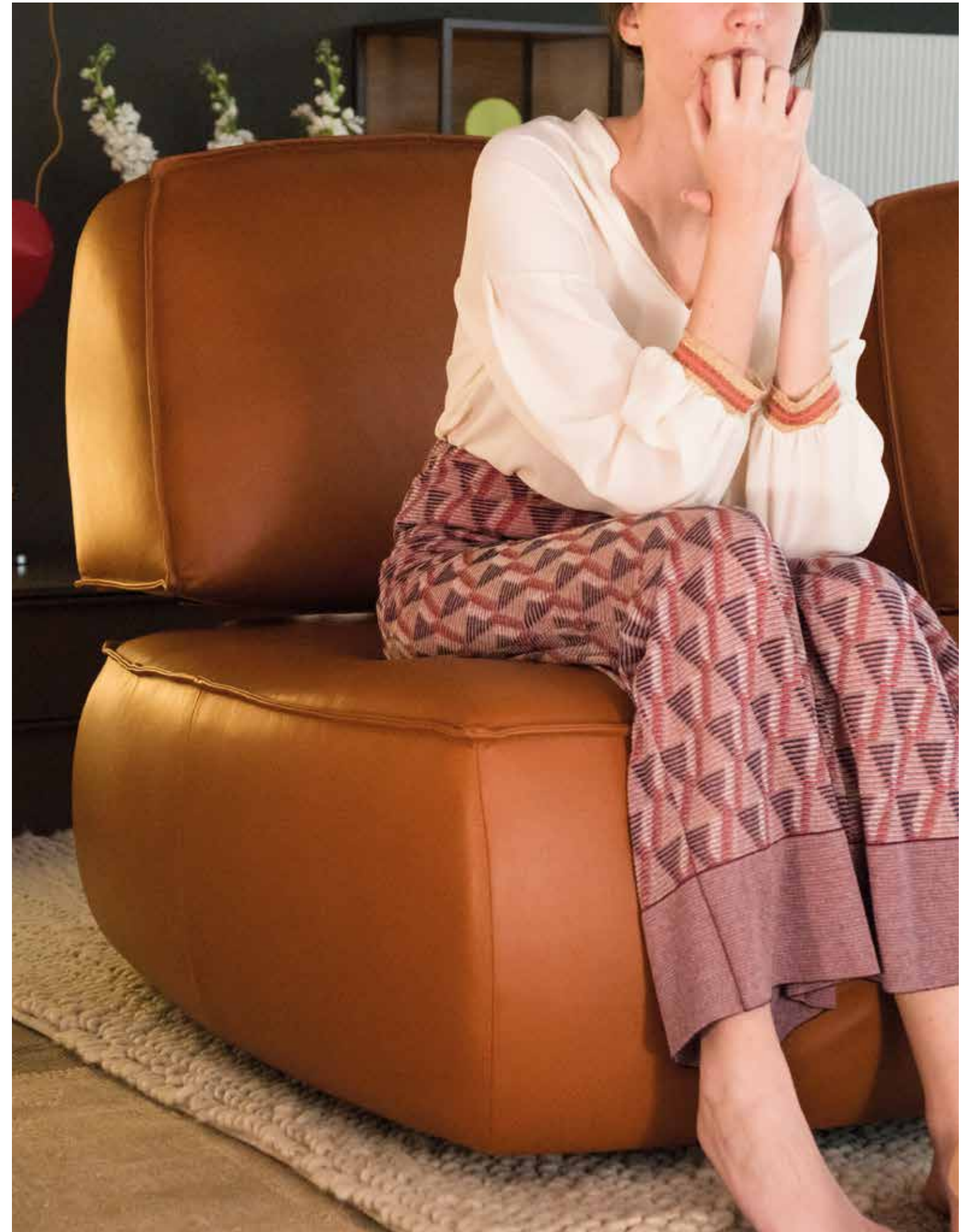

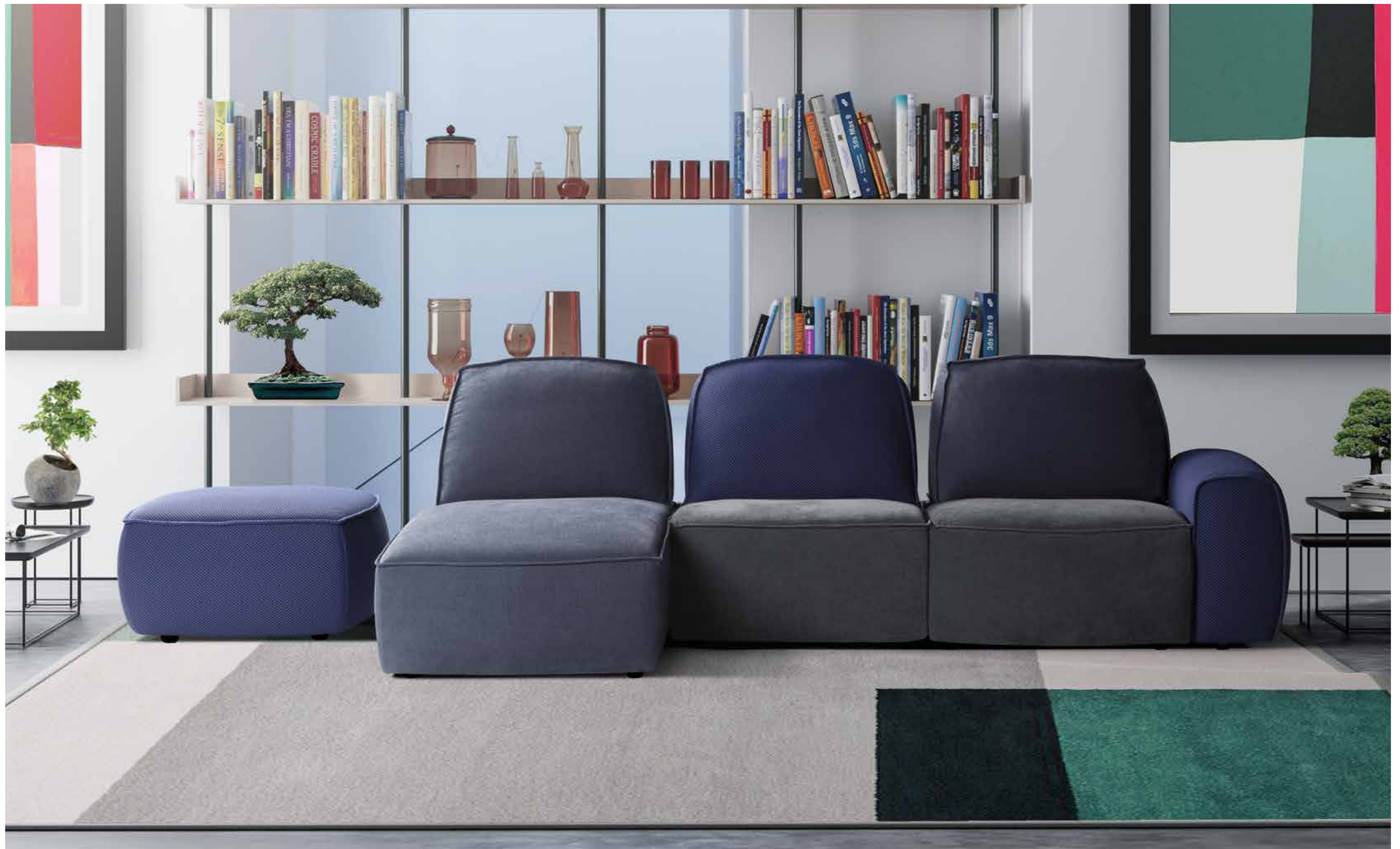



LAZY\_2 CAL1077\_2

**vers.540**

POUF  
1° RIV: RETE 3D 8349-7 BLU  
OTTOMAN  
RETE 3D 8349-7 BLU

**vers.T63**

CHAISE LONGUE SENZA BRACCIOLI  
RANGER 79 BLU  
ARMLESS CHAISE LONGUE  
RANGER 79 BLU

**vers.130**

POLTRONA SENZA BRACCIOLI  
1° RIV: RANGER 11 GRIGIO; 2° RIV: RETE 3D 8349-7 BLU  
ARMLESS CHAIR  
1st COV: RANGER 11 GRIGIO; 2nd COV: RETE 3D 8349-7 BLU

**vers.E95**

POLTRONA SENZA BRACCIOLI  
RECLINER ELETTRICO  
RANGER 11 GRIGIO  
ELECTRIC RECLINER ARMLESS CHAIR  
RANGER 11 GRIGIO

**vers.557**

POUF ANGOLO LUNGO DESTRO  
RETE 3D 8349-7 BLU  
RHF LONG CORNER OTTOMAN  
RETE 3D 8349-7 BLU

**vers.AH4**

POLTRONA 1 BRACCIOLO DESTRO  
FULL RECLINER ELETTRICO  
1° RIV: RANGER 11 GRIGIO; 2° RIV: RANGER 79 BLU  
3° RIV: RETE 3D 8349-7 BLU  
ELECTRIC RECLINER FULL RHF CHAIR  
1st COV: RANGER 11 GRIGIO; 2nd COV: RANGER 79 BLU  
3rd COV: RETE 3D 8349-7 BLU

LAZY CAL1107

**vers.AA8**

POLTRONA TERMINALE SINISTRA BASCULANTE  
PURE 4115 CUIOIO SCURO  
TILT RHF TERM. CHAIR  
PURE 4115 CUIOIO SCURO

**vers.AA7**

POLTRONA TERMINALE DESTRA BASCULANTE  
PURE 4115 CUIOIO SCURO  
TILT RHF TERM. CHAIR  
PURE 4115 CUIOIO SCURO

**LAZY\_2 CAL1107\_2**  
540+T63+130+E95+557+AH4



**LAZY CAL1107**  
AA8+AA7



**LAZY\_2 CAL1107\_2**  
540+T63+130+E95+557+AH4

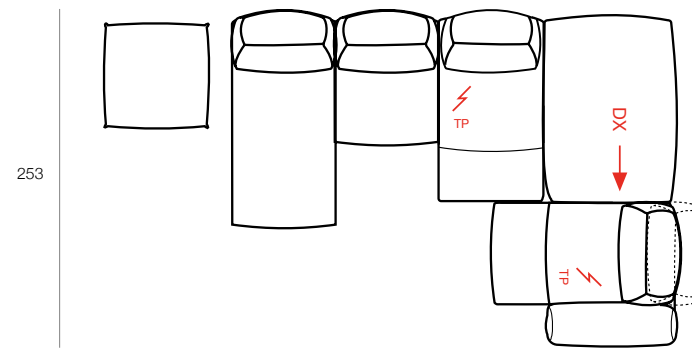

**LAZY CAL1107**  
AA8+AA7

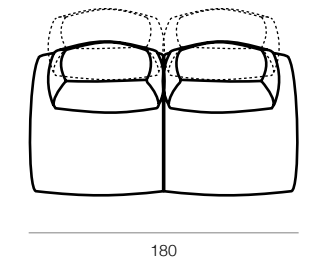

422/444



# MODULA

EXPERIENCE



Design: Daniele Della Porta

Quando la comfort experience nasce dalla varietà e dalla libertà si chiama Modula. Composto da poltrone con forme morbide e schienali alti e accoglienti, Modula prevede elementi realizzati in tre larghezze differenti che permettono di creare infinite combinazioni e soluzioni angolari per ambienti di ogni dimensione. Il bracciolo, in versione large e X, è disponibile anche come contenitore e prevede una cover in legno per l'utilizzo del computer o come base stabile su cui poggiare altri oggetti. Può inoltre essere accessorizzato con luci, porta bibite, o caricatori per tablet e smartphone. Inserito nell'ADI DESIGN INDEX 2016, nello stesso anno Modula riceve il Premio Eccellenze del Design del Lazio.

Design: Daniele Della Porta

*When the comfort experience comes from variety and freedom it is called Modula. Composed of armchairs with soft shapes and high, welcoming backrests, Modula includes elements made in three different widths that make it possible to create infinite combinations and corner solutions for environments of all sizes. The armrest, in large and X version, is also available as a container and provides a wooden cover for the use of a computer or as a stable base on which to place other objects. It can also be equipped with lights, drinks holders, or chargers for tablets and smartphones. Modula was awarded with the Premio Eccellenze del Design assigned in cooperation with the Lazio region.*

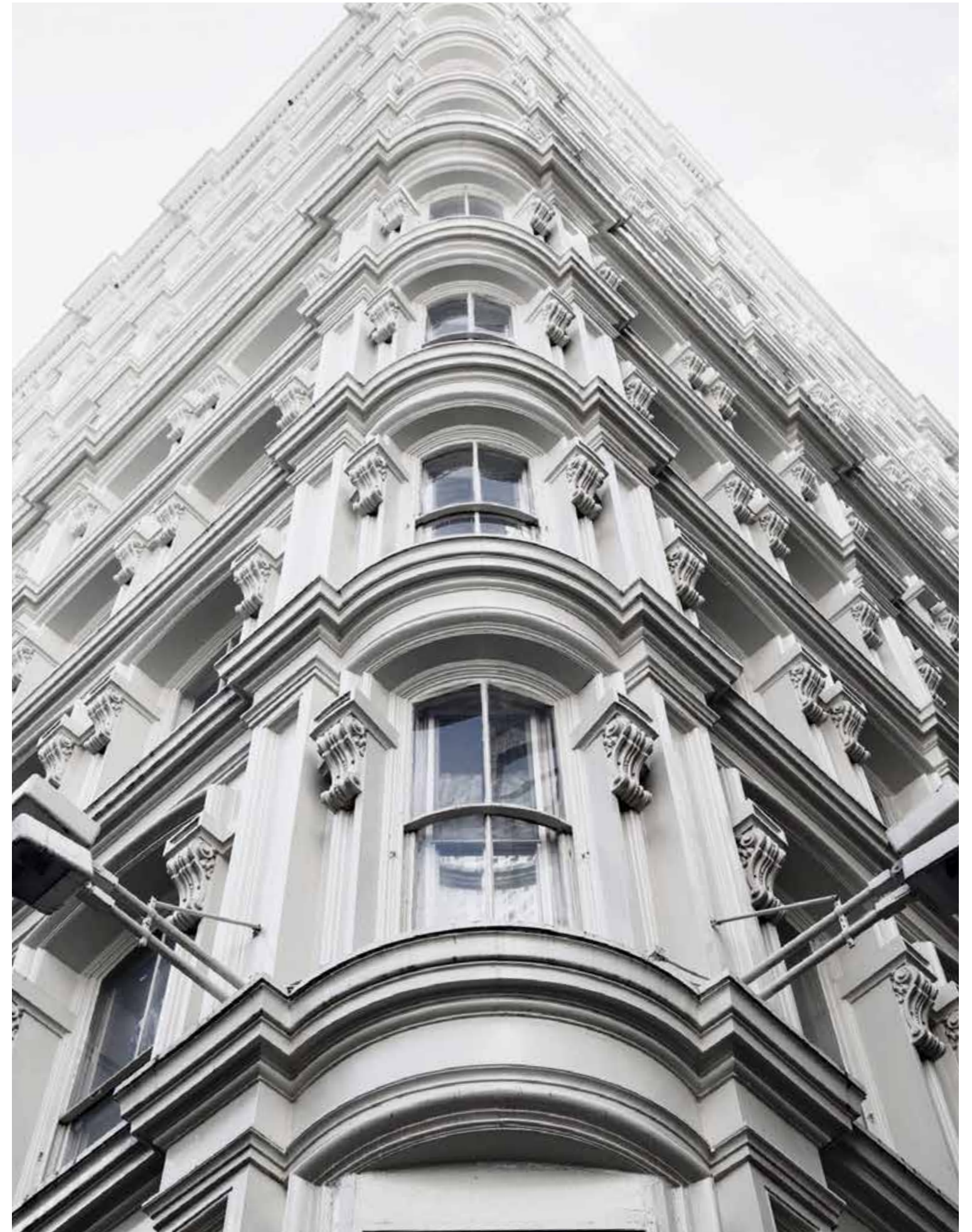

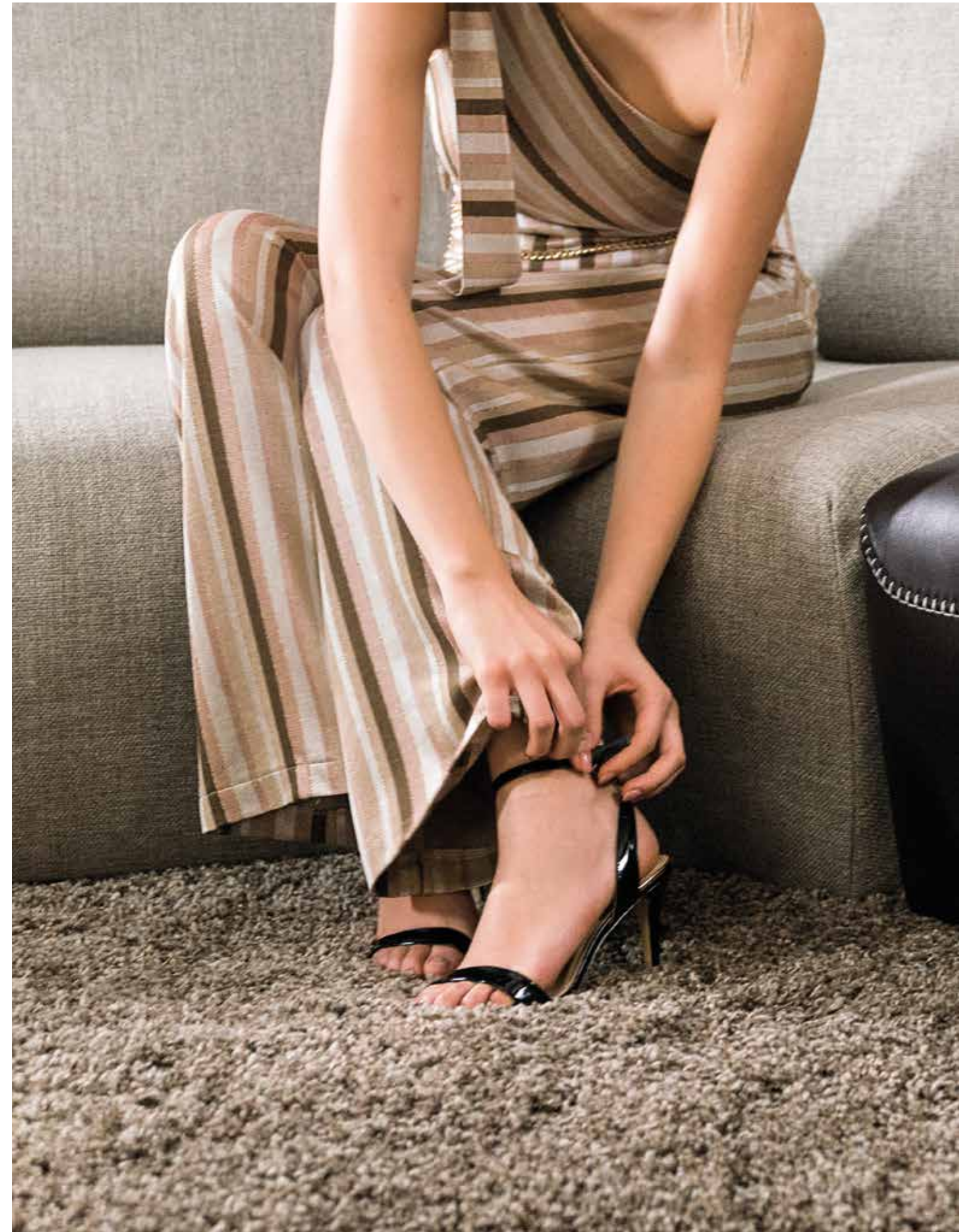



MODULA PRM1019\_1077

**vers.196**  
BRACCIOLO SMALL  
MANHATTAN 600 GRIGIO  
SMALL ARMREST  
MANHATTAN 600 GRIGIO

**vers.D62**  
POLTRONA SENZA BRACCIOLI MINI  
SUAVE 1513 TESTA DI MORO  
ARMLESS MINI CHAIR  
SUAVE 1513 TESTA DI MORO

**vers.191**  
ANGOLO SPECIAL SPALLIERA LUNGA SINISTRA  
MANHATTAN 600 GRIGIO  
LHF LONG BACK SPECIAL CORNER  
MANHATTAN 600 GRIGIO

**vers.144**  
POLTRONA SENZA BRACCIOLI MAXI  
MANHATTAN 600 GRIGIO  
144 MAXI ARMLESS CHAIR  
MANHATTAN 600 GRIGIO

**vers.198**  
BRACCIOLO LARGE  
MANHATTAN 804 GIALLO  
LARGE ARMREST  
MANHATTAN 804 GIALLO

**MODULA PRM1019\_1077**  
I96+D62+I91+144+I98

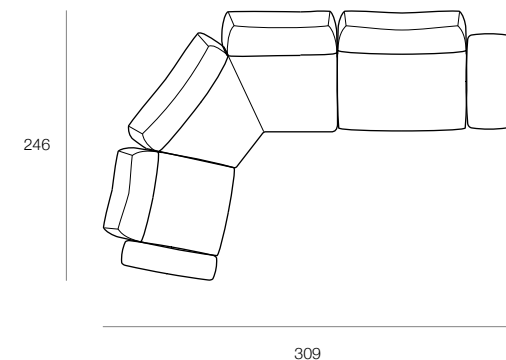

**MODULA PRM1019\_1077**  
I96+D62+I91+144+I96



# ELISEO

EXPERIENCE

Un complemento di design studiato nei minimi dettagli per garantire una comfort experience senza eguali: Eliseo è il divano modulare di Calia Italia creato per avvolgere grazie ad uno schienale flessibile che si adatta al peso del corpo e alla seduta ampia caratterizzata dagli angoli smussati che nella parte terminale si sollevano diventando bracciolo. Uno stile che conquista tutti i sensi.

*With a design conceived down to the smallest detail, Eliseo is a modular sofa by Calia Italia that guarantees an unparalleled comfort experience. Thanks to a flexible backrest that adapts to the weight of your body, along with a wide seat characterised by rounded corners that become armrests, Eliseo is designed to wrap around you in a style that will conquer all your senses.*

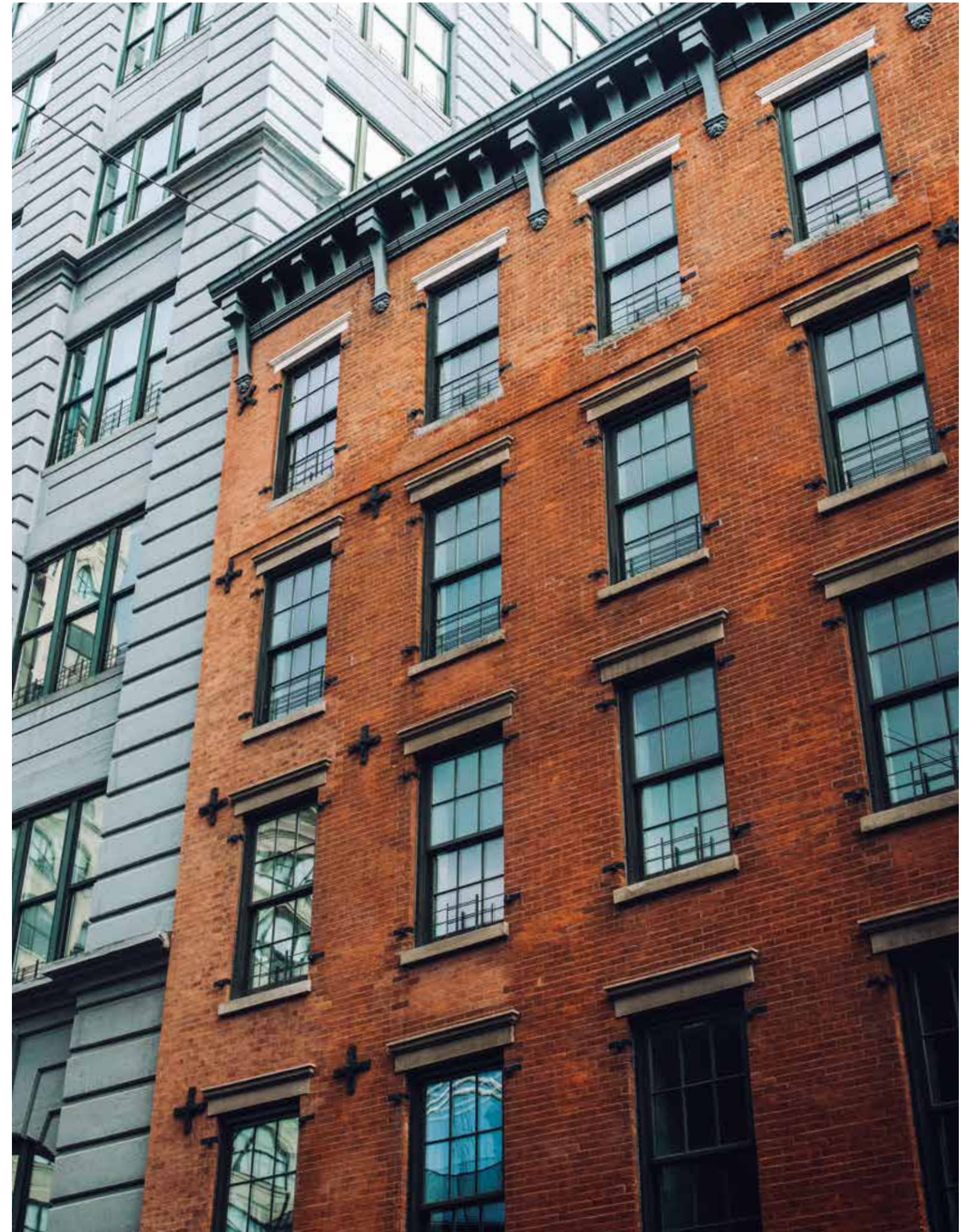



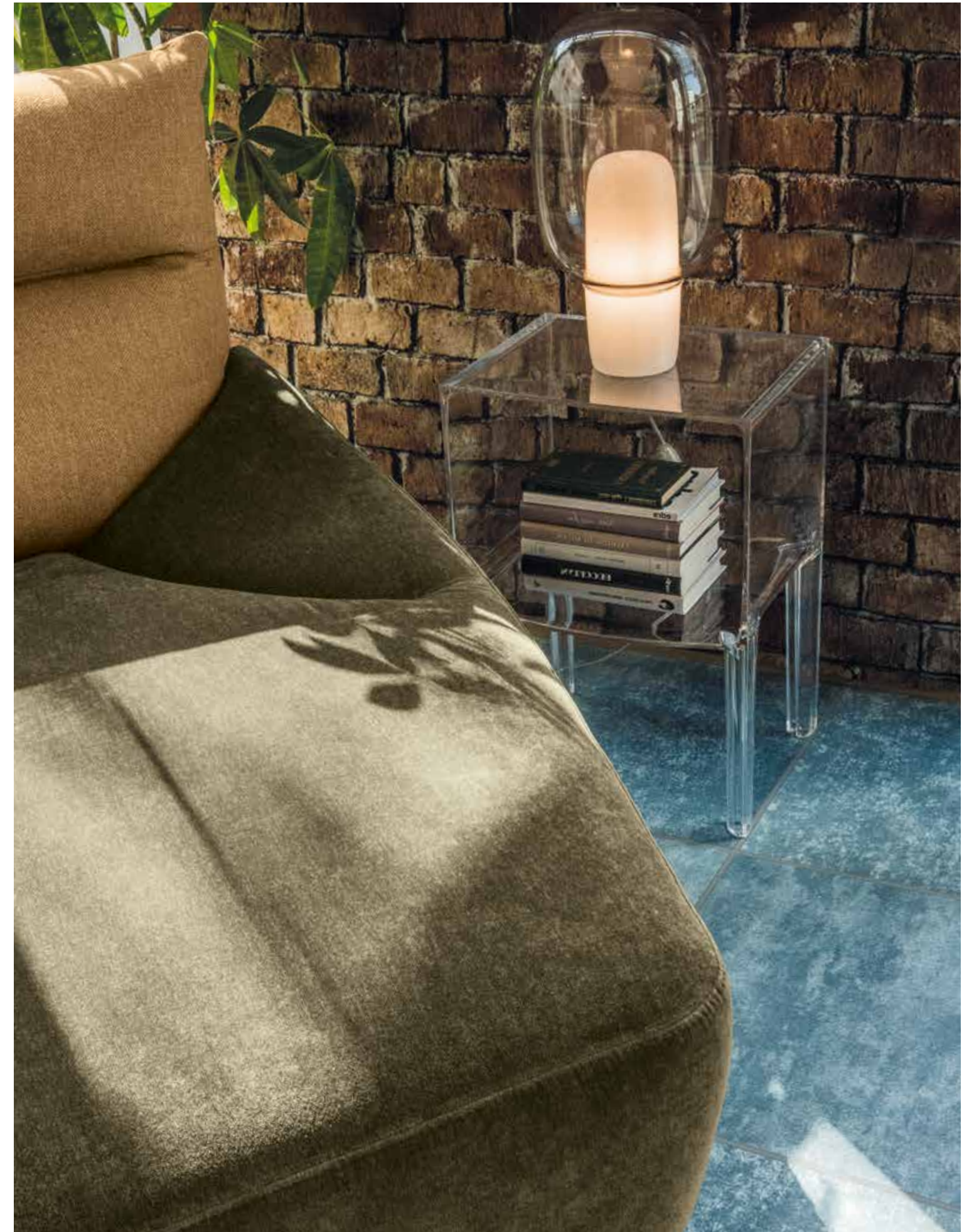



ELISEO PRM1127

**ELISEO PRM1127**  
420+130+000+110

**vers.420**  
CHAISE LONGUE 1 BRACCIOLO SINISTRO  
1° RIV: YOU 062 VERDE  
2° RIV: QUEBEC 35 SENAPE  
LHF CHAISE LONGUE  
1st COV: YOU 062 VERDE  
2nd COV: QUEBEC 35 SENAPE

**vers.130**  
POLTRONA SENZA BRACCIOLI  
1° RIV: YOU 044 ARANCIO  
2° RIV: QUEBEC 49 ROSSO  
ARMLESS CHAIR  
1st COV: YOU 044 ARANCIO  
2nd COV: QUEBEC 49 ROSSO

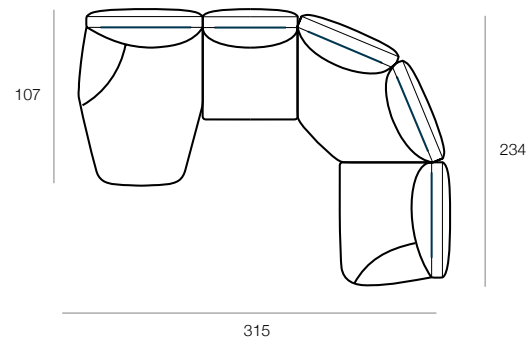

**vers.000**  
ANGOLO  
1° RIV: YOU 68 GIALLO  
2° RIV: QUEBEC 44 BEIGE  
CORNER  
1st COV: YOU 68 GIALLO  
2nd COV: QUEBEC 44 BEIGE

**vers.110**  
POLTRONA 1 BRACCIOLO DESTRO  
1° RIV: YOU 024 MUSCHIO  
2° RIV: QUEBEC 28 ACQUAMARINA  
1 RIGHT ARM FACING CHAIR  
1st COV: YOU 024 MUSCHIO  
2nd COV: QUEBEC 28 ACQUAMARINA

ELISEO PRM1127

**vers.120**  
POLTRONA  
1 BRACCIOLO SINISTRO  
GLOBE 041 BLU  
LHF CHAIR  
GLOBE 041 BLU

**vers.130**  
POLTRONA  
SENZA BRACCIOLI  
GLOBE 041 BLU  
ARMLESS CHAIR  
GLOBE 041 BLU

**vers.071**  
ANGOLO TERMINALE DESTRO  
GLOBE 041 BLU  
RH-F END CORNER  
GLOBE 041 BLU



**ELISEO PRM1127**  
120+130+071

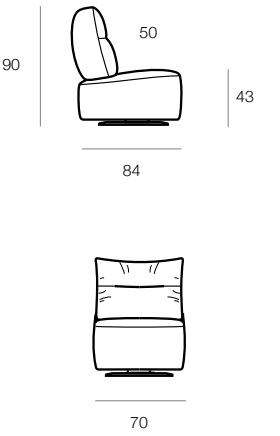

**ELISEO PRM1127**  
120+130+071

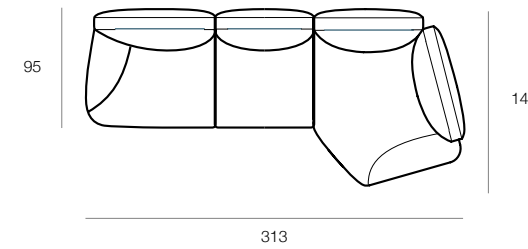

**ELISEO PRM1127**  
420+130+000+110





# TANGO

EXPERIENCE

Tango è il divano modulare che interpreta la dinamicità della vita contemporanea e la trasforma in un'esperienza di comfort. Un modello che unisce forme lineari e giochi cromatici per dare vita a composizioni fatte per accogliere e dialogare. Grazie a un meccanismo basculante, la spalliera del divano – arricchita da un soffice cuscino in piuma – cambia posizione aumentando la profondità della seduta. Tango è il divano in continuo movimento.

*Tango is a modular sofa that interprets the dynamism of contemporary life and transforms it into an experience of comfort. It is a model that combines linear shapes and chromatic interplays that gives life to compositions that are made to welcome and create dialogue. Thanks to a tilting mechanism, the backrest of the sofa (enriched by a soft feather cushion) changes position thereby increasing the depth of the seat. Indeed, Tango is a sofa in continuous movement.*

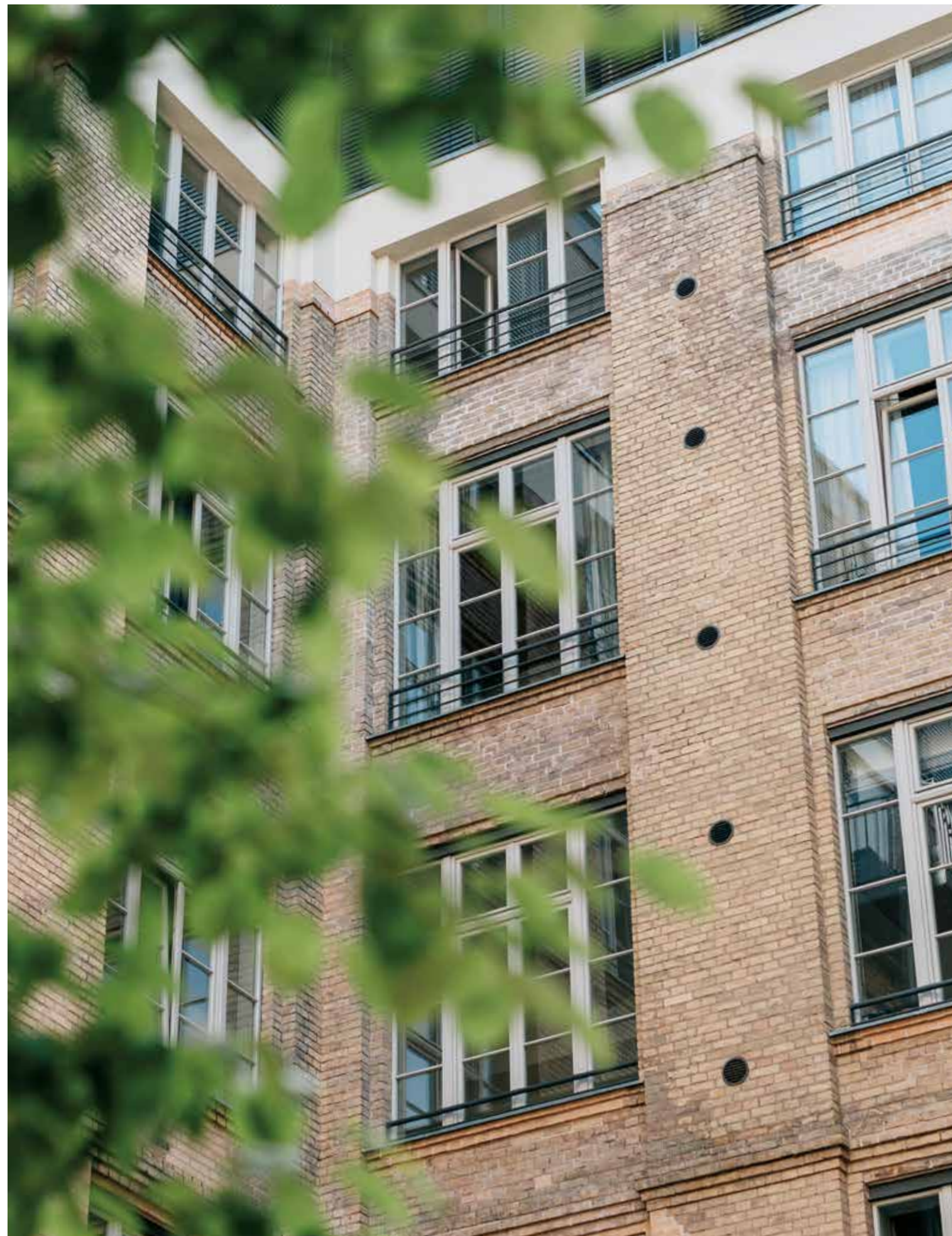







TANGO CAL827\_818

**TANGO CAL827\_818**  
130+130+560+130+635

**vers.130**  
POLTRONA SENZA BRACCIOLI  
1° RIV: RUSH POIS 202 BEIGE  
2° RIV: RUSH ASTRATTO 502 BEIGE  
3° RIV: RUSH POIS 202 BEIGE  
ARMLESS CHAIR  
1st COV: RUSH POIS 202 BEIGE  
2nd COV: RUSH ASTRATTO 502 BEIGE  
3rd COV: RUSH POIS 202 BEIGE

**vers.130**  
POLTRONA SENZA BRACCIOLI  
RUSH ASTRATTO 502 BEIGE  
ARMLESS CHAIR  
RUSH ASTRATTO 502 BEIGE

**vers.560**  
POUF BIG  
RUSH ASTRATTO 502 BEIGE  
BIG OTTOMAN  
RUSH ASTRATTO 502 BEIGE

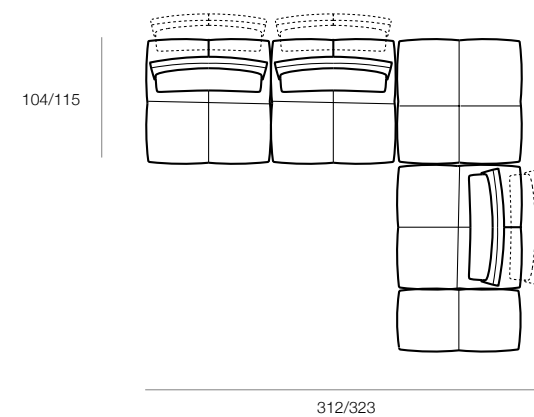

**vers.130**  
POLTRONA SENZA BRACCIOLI  
1° RIV: RUSH DISEGNO 102 BEIGE  
2° RIV: RUSH ASTRATTO 502 BEIGE  
3° RIV: RUSH DISEGNO 102 BEIGE  
ARMLESS CHAIR  
1st COV: RUSH DISEGNO 102 BEIGE  
2nd COV: RUSH ASTRATTO 502 BEIGE  
3rd COV: RUSH DISEGNO 102 BEIGE

261/272

**vers.635**  
POUF RETTANGOLARE  
PURE 4115 CUIOIO SCURO  
RECTANGULAR OTTOMAN  
PURE 4115 CUIOIO SCURO

TANGO CAL827\_818

**TANGO CAL827\_818**  
T63+130

**vers.763**  
CHAISE LONGUE SENZA BRACCIOLI  
1° RIV: RUSH DISEGNO 102 BEIGE  
2° RIV: RUSH ASTRATTO 502 BEIGE  
3° RIV: RUSH ASTRATTO 502 BEIGE  
ARMLESS CHAISE LONGUE  
1st COV: RUSH DISEGNO 102 BEIGE  
2nd COV: RUSH ASTRATTO 502 BEIGE  
3rd COV: RUSH ASTRATTO 502 BEIGE

**vers.130**  
POLTRONA SENZA BRACCIOLI  
PURE 4115 CUIOIO SCURO  
ARMLESS CHAIR  
PURE 4115 CUIOIO SCURO

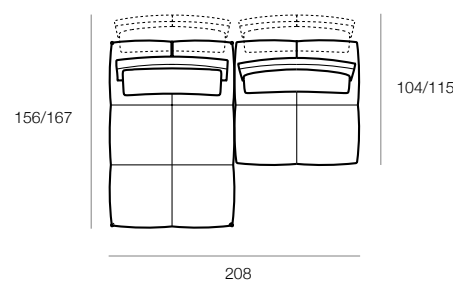

**TANGO CAL827\_818**  
T63+130



**TANGO CAL827\_818**  
130+130+560+130+635

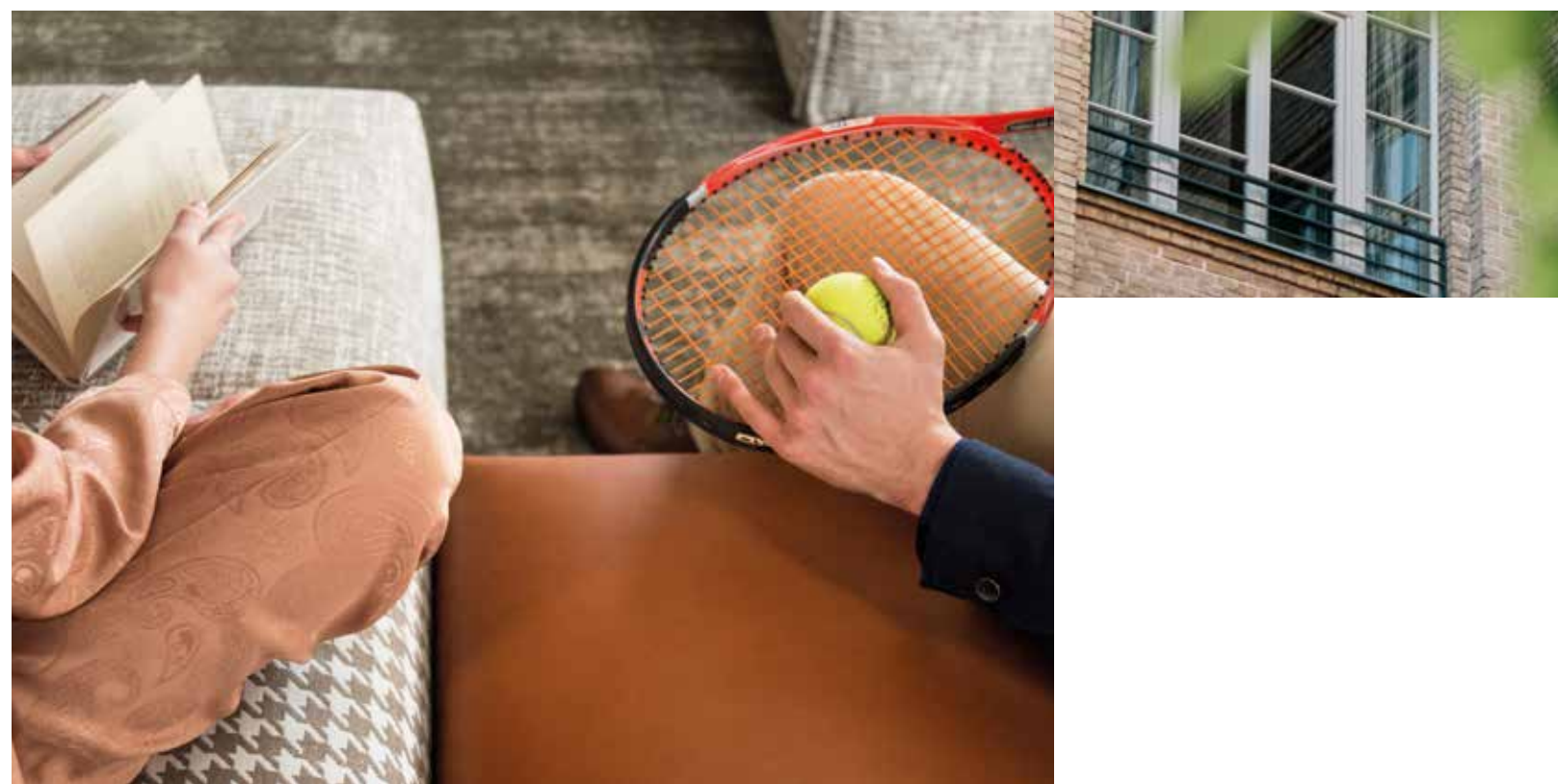





# HIP HOP

---

EXPERIENCE

Best seller della collezione, Hip Hop è una vera e propria icona del brand Calia Italia. La sua particolare forma lo rende unico sia dal punto di vista estetico che ergonomico: la silhouette del divano dà vita a una curva morbida che unisce seduta e poggiatesta, accoglie il corpo e si completa con un soffice cuscino. Un divano che prima invita e poi conquista, con una comfort experience mai provata prima. Grazie alla presenza di moduli trapezoidali Hip Hop può dare vita a composizioni originali e sinuose.

*The best seller of the collection, Hip Hop is a true icon of the brand. Its particular shape makes it unique both from an aesthetic and ergonomic point of view. The silhouette of the sofa gives life to a soft curve that combines the seat and the backrest, welcoming the body and it is completed with a soft cushion that supports the shoulders. It is a sofa that first invites you and then conquers you with a never-before-tried comfort experience. Thanks to the presence of trapezoidal modules, Hip Hop can give life to original and sinuous compositions.*









HIP HOP PRM828\_830

**HIP HOP PRM828\_830**  
E95+T71+130+130+400

**vers.E95**  
POLTRONA RECLINER  
ELETTRICO  
SENZA BRACCIOLI  
1° RIV: BABY 305  
2° RIV: BABY 600  
ARMLESS ELECTRIC  
RECLINER CHAIR  
1st COV: BABY 305  
2nd COV: BABY 600

**vers.T71**  
POLTRONA ANGOLO  
1° RIV: BABY 600  
2° RIV: BABY 705  
CORNER CHAIR  
1st COV: BABY 600  
2nd COV: BABY 705

**vers.130**  
POLTRONA SENZA BRACCIOLI  
1° RIV: BABY 804  
2° RIV: BABY 600  
ARMLESS CHAIR  
1st COV: BABY 804  
2nd COV: BABY 600

**vers.130**  
POLTRONA SENZA BRACCIOLI  
1° RIV: BABY 804  
2° RIV: BABY 500  
ARMLESS CHAIR  
1st COV: BABY 804  
2nd COV: BABY 500

**vers.400**  
CHAISE LONGUE  
1° RIV: BABY 707  
2° RIV: BABY 705  
CHAISE LONGUE  
1st COV: BABY 707  
2nd COV: BABY 705

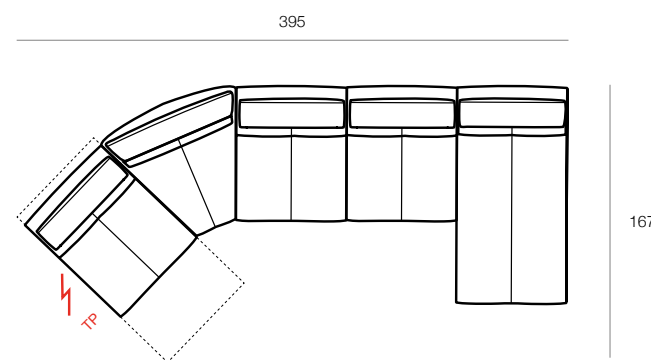

**HIP HOP PRM828\_830**  
E95+T71+130+130+400



**HIP HOP PRM828\_830**  
A99+E97+T71+130+400

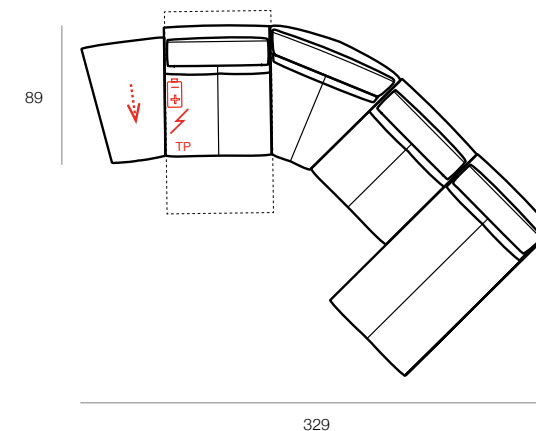

HIP HOP PRM828\_830

**vers.A99**  
POUF\_X  
GALLES 706 AZZURRO  
OTTOMAN\_X  
GALLES 706 AZZURRO

**vers.E97**  
POLTRONA RECLINER ELETTRICO  
RICARICABILE SENZA BRACCIOLI  
1° RIV: DUBAI V. 3929 AZZURRO  
2° RIV: GALLES 706 AZZURRO  
ARMLESS RECHARG. ELECTRIC RECLINER CHAIR  
1st COV: DUBAI V. 3929 AZZURRO  
2nd COV: GALLES\_706 AZZURRO

**vers.T71**  
POLTRONA ANGOLO  
1° RIV: DUBAI V. 3929 AZZURRO  
2° RIV: GALLES 706 AZZURRO  
ARMLESS RECHARG. ELECTRIC RECLINER CHAIR  
1st COV: DUBAI V. 3929 AZZURRO  
2nd COV: GALLES 706 AZZURRO

**vers.130**  
POLTRONA SENZA BRACCIOLI  
1° RIV: DUBAI V. 3929 AZZURRO  
2° RIV: GALLES 706 AZZURRO  
ARMLESS CHAIR  
1st COV: DUBAI V. 3929 AZZURRO  
2nd COV: GALLES 706 AZZURRO

**vers.400**  
CHAISE LONGUE  
1° RIV: GALLES 706 AZZURRO  
2° RIV: DUBAI V.3929 AZZURRO  
CHAISE LONGUE  
1st COV: GALLES 706 AZZURRO  
2nd COV: DUBAI V. 3929 AZZURRO



**HIP HOP PRM828\_830**  
A99+E97+T71+130+400



# FOX TROT

---

EXPERIENCE

Come una trapunta morbida e accogliente, Fox Trot è il divano modulare che avvolge con un design sinuoso e una lavorazione geometrica. Elementi lineari e angolari, chaise longue e pouf permettono di creare la composizione perfetta per i desideri e la comfort experience di chi lo sceglie.

*Like a soft and cozy quilt, Fox Trot is a modular sofa that envelops you with a sinuous design and geometric workmanship. Its linear and angular elements, chaise-longue and footstool allow you to create the perfect composition for your desires and comfort experience.*

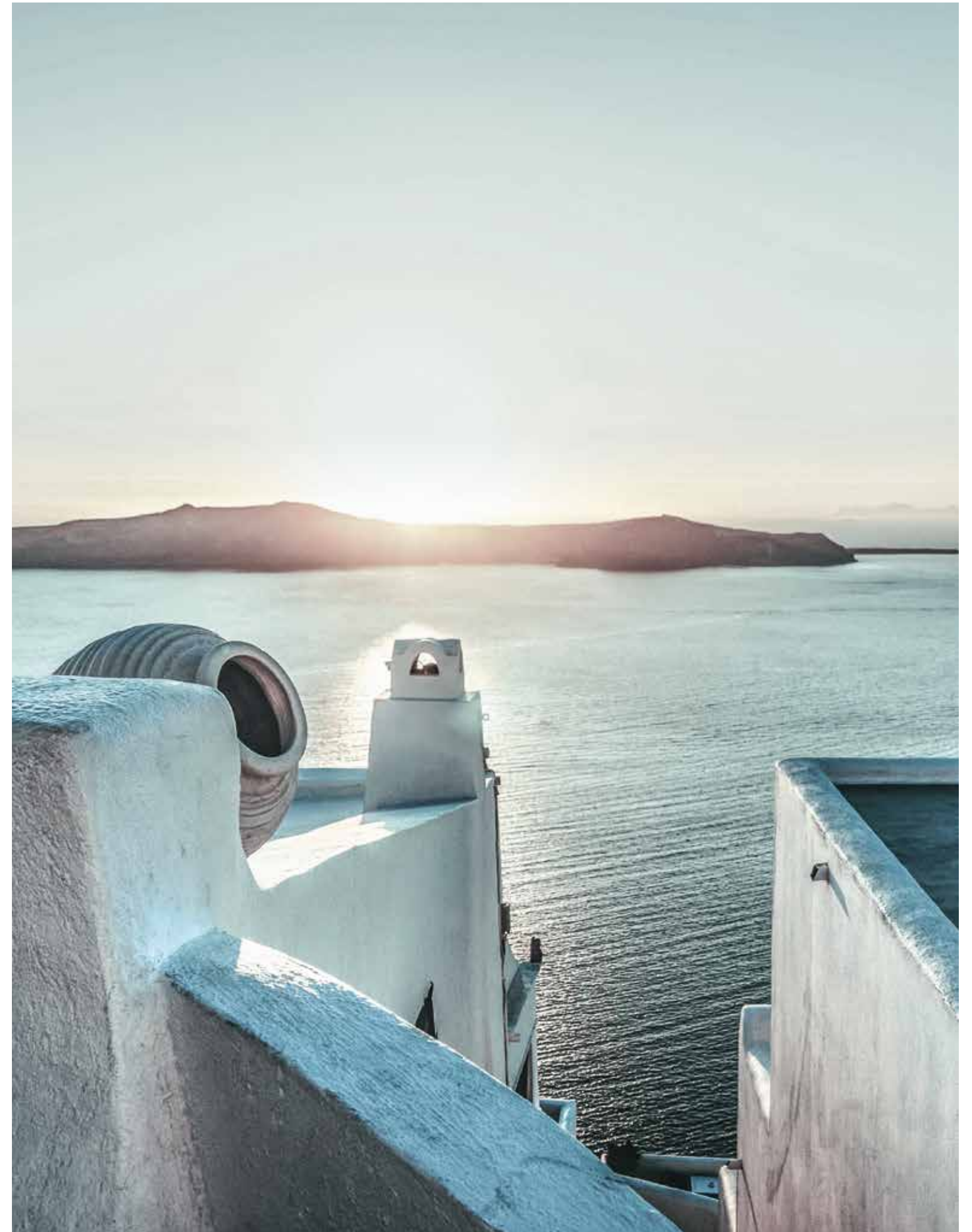









**FOX TROT PRM1063**  
400+130+130+000+130+635

FOX TROT PRM1063

**vers.400**  
CHAISE LONGUE  
DANDY 23055 COL.804 SENAPE  
CHAISE LONGUE  
DANDY 23055 COL.804 SENAPE

**vers.130**  
POLTRONA SENZA BRACCIOLI  
BULL 370 BIANCO PURO  
ARMLESS CHAIR  
BULL 370 BIANCO PURO

**vers.130**  
POLTRONA SENZA BRACCIOLI  
DUBAI V.3928 BLU  
ARMLESS CHAIR  
DUBAI V.3928 BLU

**vers.000**  
ANGOLO  
DANDY 23055 COL.804 SENAPE  
CORNER  
DANDY 23055 COL.804 SENAPE

**vers.130**  
POLTRONA SENZA BRACCIOLI  
DANDY 23055 COL.600 VERDE SCURO  
ARMLESS CHAIR  
DANDY 23055 COL.600 VERDE SCURO

**vers.635**  
POUF RETTANGOLARE  
BULL 370 BIANCO PURO  
RECTANGULAR OTTOMAN  
BULL 370 BIANCO PURO

358

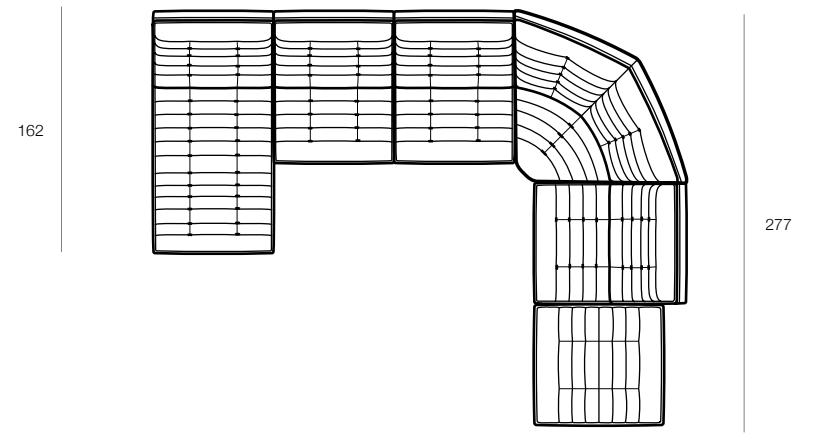

**FOX TROT PRM1063**  
400+130+130+000+130+635



# JOHNNY

---

EXPERIENCE

Componibile, multicolore, dalle soffici imbottiture: Johnny è un divano che una volta provato non si lascia più andar via. Con le sue dimensioni generose, la forma morbida, le spalliere alte e il poggiatesta regolabile manualmente -nelle versioni che lo prevedono- Johnny ha anche una versione recliner, in cui la seduta è completamente reclinabile, e una versione con bracciolo corredato di tasca portaoggetti. Un divano che dà spazio a tutte le passioni e regala una comfort experience da vivere e condividere.

*Modular, multicoloured and with soft padding, Johnny is a sofa that once you have tried it, you will never want to let it go. It has a generous size, soft shape, high backrests and manually adjustable headrest (included in selected versions) and is also available in a recliner version, in which the seat is completely reclining. There is even a version with an armrest equipped with a storage pocket. Johnny is a sofa that gives space to all passions and gives a comfort experience to live and share.*







SOU  
Kinder verkehrs garten

서울  
모델리스트  
콘테스트

1등	2등	3등	4등	5등
1명	2명	3명	4명	5명
100만원	50만원	30만원	20만원	10만원

2010.10.15. ~ 2010.11.15.



**JOHNNY PRM1136**  
781+J82+J84+J82+E95

**JOHNNY PRM1136**  
781+J82+J84+J82+E95

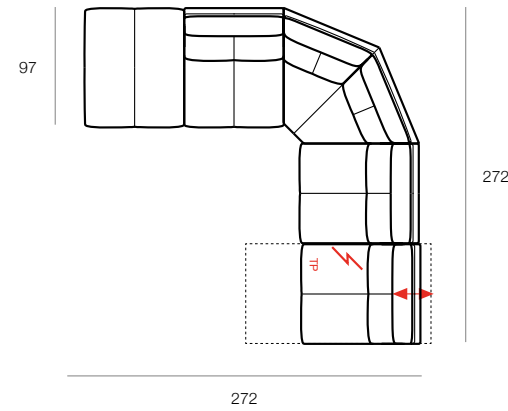

JOHNNY PRM1136

**vers.781**  
POUF MERIDIEN  
ACAPULCO 500 GIALLO  
MERIDIAN OTTOMAN  
ACAPULCO 500 GIALLO

**vers.J82**  
POLTRONA SENZA BRACCIALI POGGIATESTA FISSO  
1° RIV: ACAPULCO 402 SABBIA  
2° RIV: ACAPULCO 402 SABBIA  
3° RIV: ACAPULCO 310 ROSA  
FIXED HEADREST ARMLESS CHAIR  
1st COV: ACAPULCO 402 SABBIA  
2nd COV: ACAPULCO 402 SABBIA  
3rd COV: ACAPULCO 310 ROSA

**vers.J84**

ANGOLO POGGIATESTA FISSO  
1° RIV: ACAPULCO 301 ARANCIO; 2° RIV: ACAPULCO 301 ARANCIO  
3° RIV: ACAPULCO 406 ECRU'  
FIXED HEADREST CORNER  
1st COV: ACAPULCO 301 ARANCIO; 2nd COV: ACAPULCO 301 ARANCIO  
3rd COV: ACAPULCO 406 ECRU'

**vers.J82**

POLTRONA SENZA BRACCIALI POGGIATESTA FISSO  
1° RIV: ACAPULCO 001 VINACCIA; 2° RIV: ACAPULCO 001 VINACCIA  
3° RIV: ACAPULCO 500 GIALLO  
FIXED HEADREST ARMLESS CHAIR  
1st COV: ACAPULCO 001 VINACCIA; 2nd COV: ACAPULCO 001 VINACCIA  
3rd COV: ACAPULCO 500 GIALLO

**vers.E95**

POLTRONA RECLINER ELETTRICO SENZA BRACCIALI  
1° RIV: ACAPULCO 705 OTTANIO; 2° RIV: ACAPULCO 705 OTTANIO  
3° RIV: ACAPULCO 500 GIALLO  
ARMLESS ELECTRIC RECLINER CHAIR  
1st COV: ACAPULCO 705 OTTANIO; 2nd COV: ACAPULCO 705 OTTANIO  
3rd COV: ACAPULCO 500 GIALLO



INDICE SINOTTICI   TECHNICAL DATA INDEX	
LAZY/LAZY_2.CAL 1107/1107_2	08
MODULA.PRM 1077/1019	18
ELISEO.PRM 1127	28
TANGO.CAL 827/818	38
HIP HOP.PRM 830/828	48
FOX TROT.PRM 1063	58
JOHNNY.PRM 1136	68





Concept and artwork | BBSADV  
Art Director | Carmine Pianelli  
Photo | Sara D'Angelo  
Still life | ATIPIX

Stampato nel Marzo 2020  
Printed in March 2020

Calia Italia si riserva di apportare, senza preavviso, modifiche nei materiali, nei rivestimenti, nelle finiture e nei disegni dei prodotti di questo catalogo. I colori e le texture dei materiali e delle finiture hanno valore indicativo in quanto soggetti alle tolleranze dei processi di stampa.

*Calia italia reserves the right to change, amend and modify, without previous notice, all or any materials, covers, finishes, drawings and specifications of the products featured in this catalog. Textures and colors of materials and finishes are indicative as they are the outcome of the printing process.*

**Calia Trade S.p.A.**

*Sede Legale*  
Viale Gregorio VII, 386  
00165 Roma, Italy

*Sede Operativa*  
Contrada Serrettiello la Valle  
75100 Matera, Italy  
info@caliatrade.com  
Tel. +39 0835 303910



**CALIA ITALIA**  
OFFICIAL COMFORT SUPPLIER  
**MATERA 2019**  
EUROPEAN CAPITAL OF CULTURE

Le nostre certificazioni | Our certifications





[caliaitalia.com](http://caliaitalia.com)

